

NEW EDITION

Extraction Sets
Extracting Forceps
Root Elevators
Bone Rongeurs
Orthodontic Pliers
Scalers
Impression Trays

DENTAL INSTRUMENTS

High Quality Instruments

Manufacturer & Exporter Of Dental Instruments



**SNOWMAN
INTERNATIONAL**

 : 28 City Square, Khadim Ali Road,
Sialkot 51310 Pakistan.

 : +92-300-6181131

 : info@snowman.com.pk

 : ijaz@snowman.com.pk

 : www.snowman.com.pk

Dear Valued Buyers

We feel immense pleasure to present our latest catalogue in which we have featured a most comprehensive range of all types of quality Surgical & Dental instruments required for day to day use for Hospital. We will be pleased to quote you a competitive Price and Delivery time.

All instruments are manufactured according to the recognized standard patterns currently in use in Hospital throughout the world and are being produced under restrict control of experts to avoid any flaw and to refrain any complaint at any stage.

A group of very vast experienced persons in manufacturing handling our quality Control System.

Any instruments proven defective in workmanship or material will be replaced with out charges.

We express our thanks to all our customers for the confidence they have placed us in the past. We further assure them that we will continue our best efforts to gain their confidence in the future.

We are always at your service.

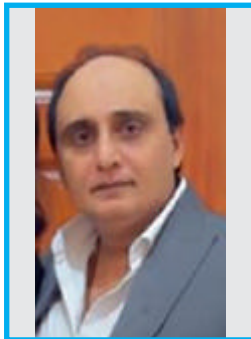

01

EXTRACTING FORCEPS

Page # 01 - 28

02

ROOT ELEVATORS

Page # 29 - 48

03

**DIAGNOSTIC, PROBES, SCALERS, FILLING
& LABORATORY INSTRUMENTS**

Page # 49 - 98

04

**MAXILLOFACIAL SURGERY
INSTRUMENTS**

Page # 99 - 124

05

**ORTHODONTIC INSTRUMENTS
& PLIERS**

Page # 125 - 144

06

**DENTAL IMPLANT INSTRUMENTS
& Impression Tray**

Page # 145 - 182

07

HOLLOWARE

Page # 183 - 191

Handle Selection For Extracting Forceps

Dear Valued Buyers if any Universal Fig. No. of Extracting Forceps not Found in our Catalogue you Can Refer the Fig. No. From These Diagram.

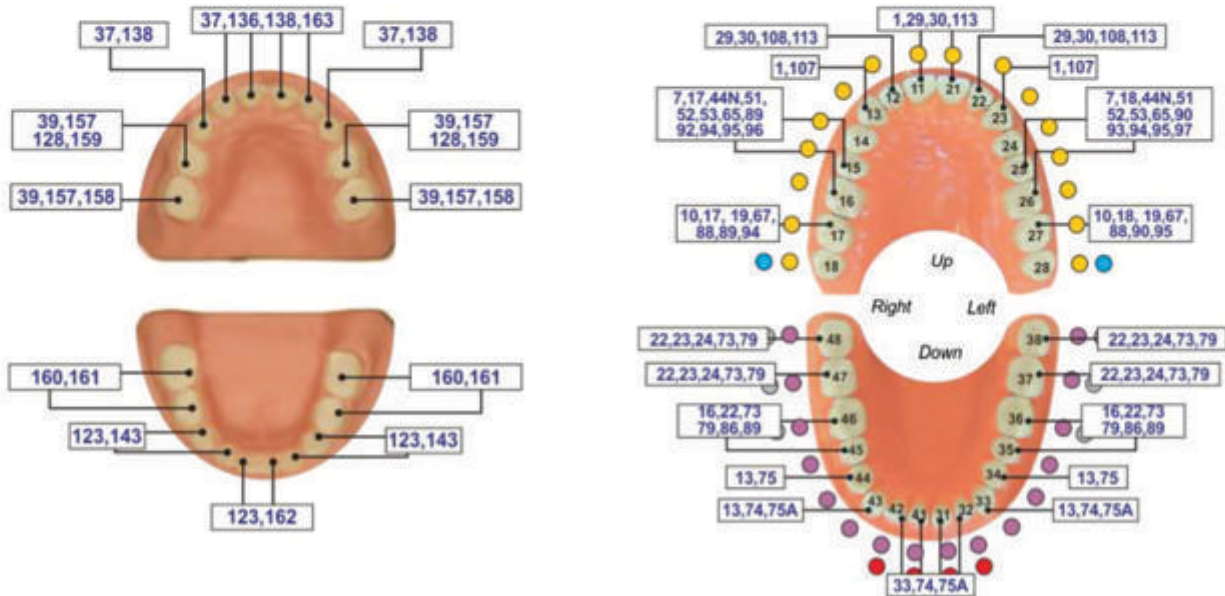

Dear Valued Buyers these are our Handle Styles



English Pattern



English Pattern



English Pattern, Anatomical Handle



American Pattern



Deep Grip Forceps With Hole Pattern



Hole Pattern



A



B



C



D



E



F

EXTRACTING FORCEPS (English Pattern)

- Щипцы экстракционные (английская форма)
- Daviers (Forme Anglaise)
- Zahnzangen (Englische Form)
- Щипці екстракційні (англійська форма)
- Forceps de Extracción (Forme Inglesa)
- استخراج الملقط (نمط اللغة الإنجليزية)

Function: To remove teeth from bony socket



SI-1001
Fig. 1
Upper Centrals
and Canines



SI-1002
Fig. 2
Upper Laterals
and Canines



SI-1003
Fig. 4
Lower Incisors
and Canines



SI-1004
Fig. 7
Upper Premolars



SI-1005
Fig. 8
Lower Premolars



SI-1006
Fig. 13
Lower Premolars



SI-1007
Fig. 17
Upper Molars,
Right



SI-1008
Fig. 18
Upper Molars, Left



SI-1009
Fig. 21
Lower Molar



SI-1010
Fig. 22
Lower Molar



Straight extracting forceps for upper incisors and canines



Straight extracting forceps for upper incisors and canines



Straight extracting forceps for upper incisors and canines

EXTRACTING FORCEPS (English Pattern)

- Щипцы экстракционные (английская форма)
- Daviers (Forme Anglaise)
- Zahnzangen (Englische Form)
- Щипці екстракційні (англійська форма)
- Forceps de Extracción (Forme Inglesa)
- استخراج الملقط (نمط اللغة الإنجليزية)

Function: To remove teeth from bony socket



SI-1011
18A
upper molars



SI-1012
19
upper third molars



SI-1013
20
lower third molar



SI-1014
24
lower molar, right



SI-1015
29
upper roots



SI-1016
30
Upper Roots



SI-1017
33
lower roots



SI-1018
33A
Lower Roots



SI-1019
33M
Lower roots
with long beak



SI-1020
46L



SI-1021
51
Upper Roots



SI-1022
51A
Upper Roots



Straight extracting forceps for upper incisors and canines



Straight extracting forceps for upper incisors and canines



Straight extracting forceps for upper incisors and canines

EXTRACTING FORCEPS (English Pattern)

- Щипцы экстракционные (английская форма)
- Щипці екстракційні (англійська форма)
- Daviers (Forme Anglaise)
- Forceps de Extracción (Forme Inglesa)
- Zahnzangen (Englische Form)
- استخراج الملقط (نمط اللغة الإنجليزية)

Function: To remove teeth from bony socket

WISDOM EXTRACTING FORCEPS



SI-1023
Routerier
(# 22 ½ L)
lower molars and
wisdoms, left



SI-1024
Routerier
(# 22 ½ R)
lower molars and
wisdoms, right



SI-1025
Routerier
(# 33 ½ L)
lower molar and
wisdom roots, left



SI-1026
Routerier
(# 33 ½ R)
lower molar and
wisdom roots, right



Routerier extracting forceps for lower molars and third molars, right



SI-1027
Fig. 186L
lower molars



SI-1028
Fig. 186R
lower molars



SI-1029
51AL



SI-1030
67
Upper Third Molars



SI-1031
67A
Upper Third Molars



SI-1032
79
Lower Third Molars



Angled extracting forceps for upper roots

EXTRACTING FORCEPS (English Pattern)

- Щипцы экстракционные (английская форма)
- Daviers (Forme Anglaise)
- Zahnzangen (Englische Form)
- Щипці екстракційні (англійська форма)
- Forceps de Extracción (Forme Inglesa)
- استخراج الملقط (نمط اللغة الإنجليزية)



SI-1034
73 A
lower molars



SI-1035
73 S



SI-1036
74
Lower Roots



SI-1037
74N
Lower Roots



SI-1038
75
Lower Premolars



SI-1039
86A
Lower Molars



SI-1040
86B
lower molars



SI-1041
86C
lower molars



SI-1042
87
Lower Molars



SI-1043
89
Upper Molars,
Right



SI-1044
90
Upper Molars,
Left



SI-1033
73
Lower Molars



Straight extracting forceps for upper incisors and canines



Straight extracting forceps for upper incisors and canines



Straight extracting forceps for upper incisors and canines

EXTRACTING FORCEPS (English Pattern)

- Щипцы экстракционные (английская форма)
- Daviers (Forme Anglaise)
- Zahnzangen (Englische Form)
- Щипці екстракційні (англійська форма)
- Forceps de Extracción (Forme Inglesa)
- استخراج الملقط (نمط اللغة الإنجليزية)

DE-TRAUMATIC EXTRACTION

Improved tapered beaks for complete root contact. Cross serrations. Deep Gripe Extracting Forceps



- No Fracture
- No Tissue Damage
- Extraction With Easy



Thin Tip

SI-1045
34
Upper incisors and
premolars
deep-gripping



Wide Tip

SI-1046
34A
Upper centrals / cains
deep-gripping



Thin Tip

SI-1047
Fig. 35
upper premolars
deep-gripping



Wide Tip

SI-1048
35A
Upper incisors and
premolars
deep-gripping



Thin Tip

SI-1049
36
Lower premolars
deep-gripping



Wide Tip

SI-1050
36A
Lower premolars
deep-gripping



SI-1051
336
lower premolars
deep-gripping



SI-1052
F-7C
lower molar



SI-1053
9
Apex Forceps Lower Universal
Deep Root Pick



SI-1054
79N
Lower third molars
deep-gripping



SI-1055
79
Lower Thrid Molars

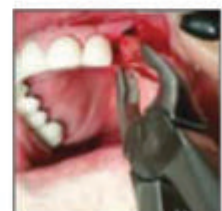

Function:

Extraction forceps are used to further loosen teeth by rotational and tilting movements and finally to extract the teeth in combination with a fulcrum.

EXTRACTING FORCEPS (English Pattern)

- Щипцы экстракционные (английская форма)
- Daviers (Forme Anglaise)
- Zahnzangen (Englische Form)
- Щипці екстракційні (англійська форма)
- Forceps de Extracción (Forme Inglesa)
- استخراج الملقط (نمط اللغة الإنجليزية)

DEEP ROOT PICK FORCEPS



SI-1056
146

Apex Forceps Lower Root
Deep Root Pick



SI-1057
153

Apex Forceps Upper Root
Deep Root Pick



SI-1058
149

Apex Forceps Upper Root
Deep Root Pick



SI-1059
Fig. 44



SI-1060
Fig. 44Z



SI-1061
Fig. 45Z



SI-1062
46XL
Apex Forceps Lower Root
Deep Root Pick



SI-1063
67

Upper Third Molars



SI-1064
67A

Upper Third Molars



SI-1065
67N

Lower third molars
deep-gripping



SI-1066
331

upper roots
deep-gripping



forceps for upper incisors, premolars and roots



EXTRACTING FORCEPS (English Pattern)

- Щипцы экстракционные (английская форма)
- Daviers (Forme Anglaise)
- Zahnzangen (Englische Form)
- Щипці екстракційні (англійська форма)
- Forceps de Extracción (Forme Inglesa)
- استخراج الملقط (نمط اللغة الإنجليزية)



Fig. 1
upper
laterals
and canines



SI-1067
Set of 10 Pieces
Fig. 1
Fig. 7
Fig. 13
Fig. 17
Fig. 18
Fig. 22
Fig. 51A
Fig. 67
Fig. 74N
Fig. 79

Fig. 7
upper premolars



Fig. 13
lower premolars



Fig. 17
upper molars, right



Fig. 18
upper molars, left



Fig. 22
lower roots



Fig. 51A
upper roots



Fig. 67
upper third molars



Fig. 74N
lower molar



Fig. 79
lower third molars



Extracting forceps for upper roots



- Щипцы экстракционные
- Щипці екстракційні
- Daviers
- Forceps de Extracción
- Zahnzangen
- استخراج المنطق

Pediatric Tooth Extracting Forceps Set



SI-1068
English Pattern Klein #51S
Pedodontic Upper root



SI-1069
English Pattern Klein #137
Pedodontic, Upper Incisors Spring handle



SI-1070
English Pattern Klein #5
Pedodontic Lower Incisors.



SI-1071
English Pattern Klein #139
Pedodontic Upper Premolars

Baby Tooth Extraction Forceps



SI-1072
Fig. # 01 to 07
Set of 7 Pieces



SI-1073
English Pattern Klein #7
Pedodontic Lower Roots,



SI-1074
English Pattern Klein #3
Pedodontic Upper Molars Universal

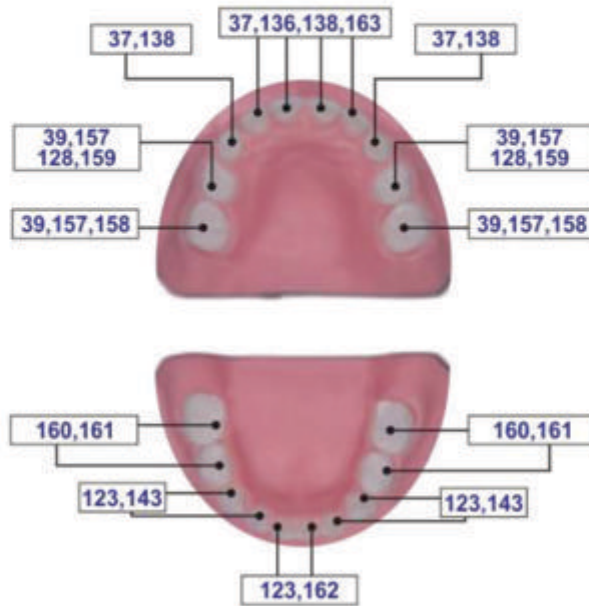

SI-1075
English Pattern Klein #6
Pedodontic Lower Molars, Spring Handle



Witzel
SI-1076
170mm
Upper roots, Universal



Witzel
SI-1077
165mm
Lower roots, Universal



SI-1078
#400(300)
165mm
Upper roots, Universal



SI-1079
#401(301)
160mm
Lower roots, Universal



SI-1080
Witzel Forceps With Gold
Set of 3 Pcs



SI-1081
Witzel Forceps With Hole And Screw Pattern
Set of 3 Pcs



SI-1082
Witzel Forceps With Anatomical Handle
Set of 3 Pcs



SI-1083
#401(301)
160mm
Lower roots, Universal



SI-1084
#401(301)
160mm
Lower roots, Universal



SI-1085
#401(301)
160mm
Lower roots, Universal



SI-1086
#400(300)
165mm
Upper roots, Universal



SI-1087
#400(300)
165mm
Upper roots, Universal



SI-1088
#400(300)
165mm
Upper roots, Universal



Witzel
SI-1089
165mm
Lower roots, Universal



Witzel
SI-1090
165mm
Lower roots, Universal



Witzel
SI-1091
165mm
Lower roots, Universal

ROOTS SPLINTER FORCEPS

- Щипцы для удаления корневых осколков
- Pincas Fragments
- Wurzelsplitterzangen
- Щипці для видалення корневих осколків
- Pinzas Para Fragmentos
- جنور منشقة المنطق



SI-1092
Splinter Forceps
15.5cm



Stieglitz Root Splinter Forceps



SI-1093
Splinter Forceps
15.5cm 45°



SI-1094
Stieglitz
Root Fragments



SI-1095
Stieglitz
Root Fragments



SI-1096
Stieglitz Splinter Forceps
140mm 90°

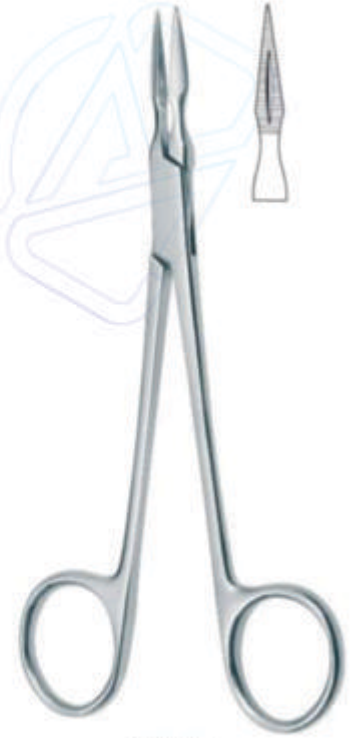

SI-1097
Stieglitz Splinter Forceps
140mm Straight



SI-1098
130mm

With Diamond



SI-1099
130mm

With Diamond



SI-1100
125mm

With Diamond



SI-1101
130mm



SI-1102
130mm



SI-1103
125mm

EXTRACTING FORCEPS (American Pattern)

- Щипцы экстракционные (американская форма)
- Daviers - forme américaine
- Fórceps de extracción - forma americana
- Щипці екстракційні (американська форма)
- Pinzere per estrazione - forma americana
- استخراج الملقط (النمط الأمريكي)



SI-1104
1STD
Winter
upper centrals and canines

SI-1105
Fig. 1
upper incisors
and roots

SI-1106
Cryer
Fig. 150

EXTRACTING FORCEPS (American Pattern)

- Щипцы экстракционные (американская форма)
- Щипцы екстракційні (американська форма)
- Daviers - forme américaine
- Pinzeper per estrazione - forma americana
- Fórceps de extracción - forma americana
- استخراج المنطق (النمط الأمريكي)



SI-1107
Fig. 150A
Cryer
upper incisors, premolars, roots



SI-1108
Fig. 62
incisors, premolars,
deciduous teeth



SI-1109
10S
upper roots



SI-1110
17
lower molars



SI-1111
Harris
Fig. 18R



SI-1112
Harris
Fig. 18L

EXTRACTING FORCEPS (American Pattern)

- Щипцы экстракционные (американская форма)
- Daviers - forme américaine
- Férceps de extracción - forma americana
- Щипці екстракційні (американська форма)
- Pinzere per estrazione - forma americana
- استخراج الملقط (الأمريكي)



SI-1113
Fig. 210
upper third molars



SI-1114
Fig. 53R
upper molars, right



SI-1115
Fig. 53L
upper molars, left



SI-1116
NEVIUS
Fig. 88R



EXTRACTING FORCEPS (American Pattern)

- Щипцы экстракционные (американская форма)
- Щипці екстракційні (американська форма)
- Daviers - forme américaine
- Pinzere per estrazione - forma americana
- Fórceps de extracción - forma americana
- استخراج المنقط (النمط الأمريكي)



SI-1117
Fig. 24
upper molars



SI-1118
210S
upper third molars



SI-1119
210H
upper third molars



SI-1120
286
Upper Roots,
Premolars, Incisors



SI-1121
99C
Kells
upper incisors,
canines, premolars



SI-1122
222
lower third molars



SI-1123
286
Lower Molar

EXTRACTING FORCEPS (American Pattern)

- Щипцы экстракционные (американская форма)
- Dáviers - forme américaine
- Fórceps de extracción - forma americana
- Щипці екстракційні (американська форма)
- Pinzere per estrazione - forma americana
- استخراج الملقط (النمط الأمريكي)



SI-1124
Nevius
Fig. 88L
upper molars, left



SI-1125
Fig. 65
upper incisors
and roots



SI-1126
Parmly Fig. 32A
upper premolars
and roots



SI-1127
Parmly Fig. 32
upper premolars
and molars

EXTRACTING FORCEPS (American Pattern)

- Щипцы экстракционные (американская форма)
- Щипці екстракційні (американська форма)
- Daviers - forme américaine
- Pinzere per estrazione - forma americana
- Fórceps de extracción - forma americana
- استخراج المنطق (النمط الأمريكي)

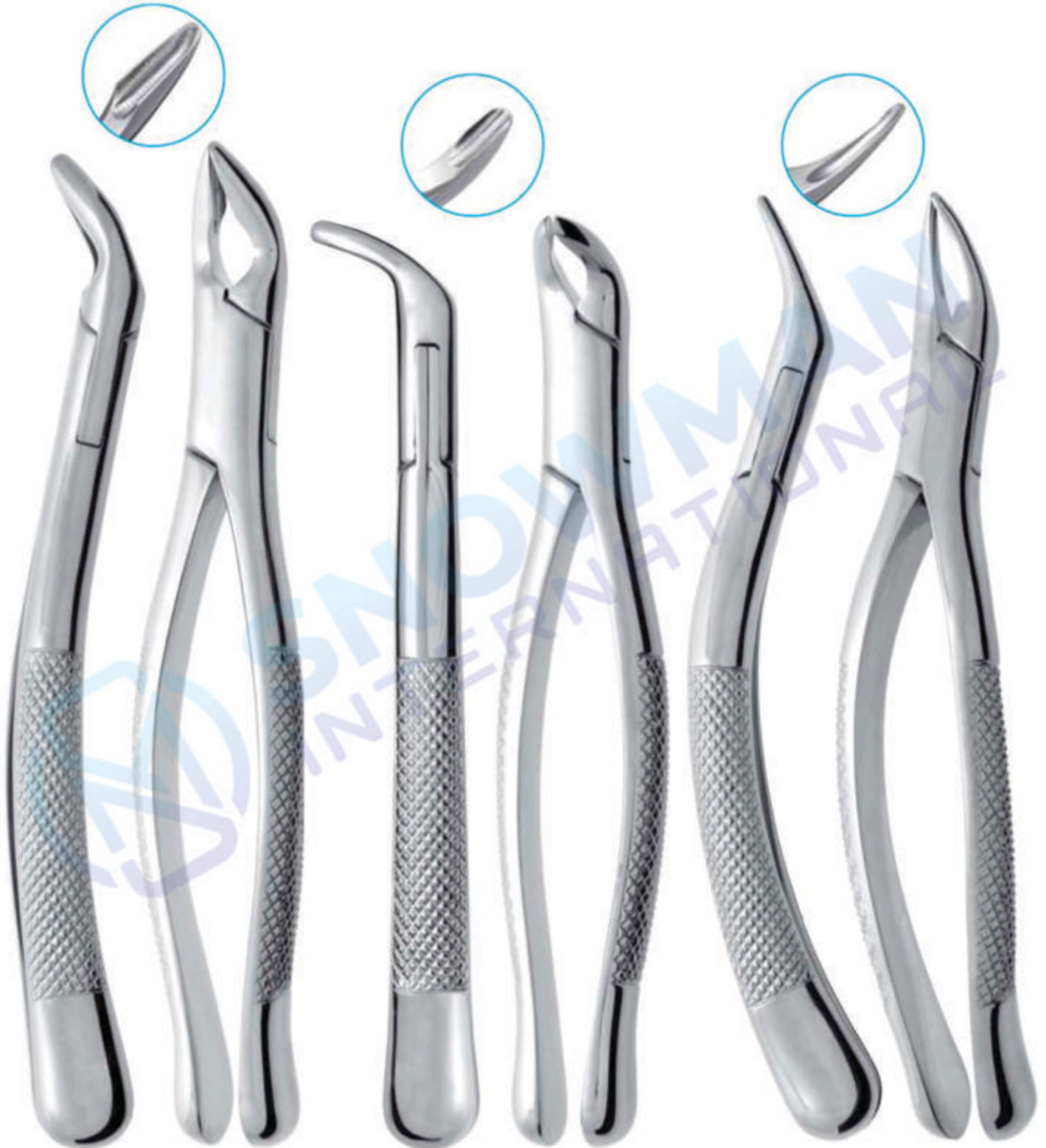

SI-1128
COHEN
universal

SI-1129
Fig. 203
lower incisors
and roots

SI-1130
Tomes Fig. 69
upper and lower
roots

EXTRACTING FORCEPS (American Pattern)

- Щипцы экстракционные (американская форма)
- Щипці екстракційні (американська форма)
- Daviers - forme américaine
- Pinzere per estrazione - forma americana
- Fórceps de extracción - forma americana
- استخراج الملقط (الأمريكي)



EXTRACTING FORCEPS (American Pattern)

- Щипцы экстракционные (американская форма)
- Щипці екстракційні (американська форма)
- Daviers - forme américaine
- Pinzeper per estrazione - forma americana
- Fórceps de extracción - forma americana
- استخراج المنقط (النمط الأمريكي)



SI-1136
Hull
Fig. 101
Deciduous teeth

SI-1137
Cryer
Fig. 150S
upper teeth,
for children

SI-1138
Fig. 150 AS

EXTRACTING FORCEPS (American Pattern)

- Щипцы экстракционные (американская форма)
- Daviers - forme américaine
- Fórceps de extracción - forma americana
- Щипці екстракційні (американська форма)
- Pinzere per estrazione - forma americana
- استخراج الملقط (النمط الأمريكي)



SI-1139
Cryer
Fig. 151
lower teeth,
for children

SI-1140
Fig. 151 S
lower incisors,
premolars, roots

SI-1141
Fig. 151 AS

EXTRACTING FORCEPS (American Pattern)

- Щипцы экстракционные (американская форма)
- Щипці екстракційні (американська форма)
- Daviers - forme américaine
- Pinzere per estrazione - forma americana
- Fórceps de extracción - forma americana
- مستطاح المنطق (النمط الأمريكي)



SI-1142
16S
lower molars for children



SI-1143
17S
lower molars



SI-1144
23 S
Lower molars

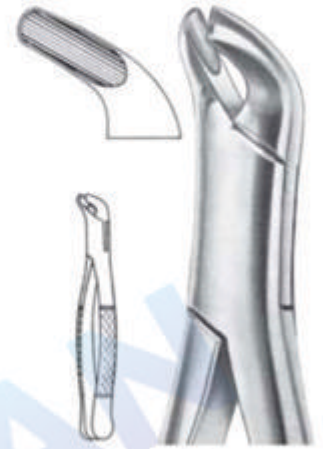

SI-1145
27
lower molars



SI-1146
18LS
upper molars left



SI-1147
18RS
upper molars right



SI-1148
85 Tomas
lower canines, premolars and molars



SI-1149
85A Tomas
lower canines, premolars and molars



SI-1150
69S
upper and lower roots



SI-1151
99A Kells
upper incisors, canines, premolars



SI-1152
217
lower molars

EXTRACTING FORCEPS (American Pattern)

- Щипцы экстракционные (американская форма)
- Daviers - forme américaine
- Férceps de extracción - forma americana
- Щипці екстракційні (американська форма)
- Pinzener per estrazione - forma americana
- استخراج الملقط (النمط الأمريكي)



SI-1153
#10 SK
Upper Molars Sup



SI-1154
#17 SK Universal
Lower Molars



SI-1155
#23 SK Universal
Upper Molars



SI-1156
#69 SK Tomas
upper and lower roots



SI-1157
#99 SK
upper incisors,
canines, premolars



SI-1158
#150 SK
upper incisors,
premolars, roots



SI-1159
#151 SK
lower incisors,
premolars, roots



SI-1160
#222 SK
lower third molars

EXTRACTING FORCEPS (American Pattern)

- Щипцы экстракционные (американская форма)
- Щипцы екстракційні (американська форма)
- Daviers - forme américaine
- Pinzere per estrazione - forma americana
- Férceps de extracción - forma americana
- مستطراج المنطق (المنطق الأمريكي)



SI-1161
Fig. 1
Upper Anterior

SI-1162
Lower Molar
Fig. 23 Cow Horn



SI-1163
Fig. 74
Lower Anterior



SI-1164
Fig. 88L
Upper Molar Left



SI-1165
Fig. 88R
Upper Molar Right



SI-1166
Fig. 74
Lower Anterior



SI-1167
Fig. 106
Lower Incisors



SI-1168
Fig. 174
Extra Narrow
Lower Anterior
Apical Retention
Forceps



SI-1169
Fig. 859
Lower Molars
Roots



EXTRACTING FORCEPS (American Pattern)

- Щипцы экстракционные (американская форма)
- Щипці екстракційні (американська форма)
- Pinzere per estrazione - forma americana
- Pinzere per estrazione - forma americana
- Férceps de extracción - forma americana
- استخراج الملقط (النمط الأمريكي)

Carbide Diamond Coated Point



SI-1170
150 T.C.
Carbide Serrated Beak
Upper Incisors, Cuspids,
Bicuspid & Roots,
Universal



SI-1171
151 T.C.
Carbide Serrated Beak
Lower Incisors, Cuspids,
Bicuspid & Roots, Universal



SI-1172
1STD T.C.
Carbide Serrated Beak
Upper Incisors, Cuspids,



SI-1173
17 T.C.
Carbide Serrated Beak
1st & 2nd Lower Molars,
Universal



SI-1174
53L T.C.
Carbide Serrated Beak
1st & 2nd Upper Molars,
Left



SI-1175
53R T.C.
Carbide Serrated Beak
1st & 2nd Upper Molars,
Right



SI-1176
65 T.C.
Carbide Serrated Beak
Upper Incisors, Roots &
Fragments



SI-1177
69 T.C.
Carbide Serrated Beak
Upper & Lower Fragments
And Roots



SI-1178
150S T.C. Pedro forcep
Carbide Serrated Beak
Pedo, Upper Primary Teeth
and Roots, Universal



SI-1179
151S T.C. Pedro forcep
Carbide Serrated Beak
Pedo, Lower Primary Teeth
and Roots, Universal

BONE ROUNGER

- Костные кусачки
- Hohlmelßelzangen
- Pincés-gouges
- Кусачки для кісток
- Pinzas-gubias
- روتجورس العظام



SI-1180
Blumenthal
15cm



SI-1181
Blumenthal
15cm



SI-1182
Blumenthal
15cm



SI-1183
Friedman
14cm



SI-1184
Friedman
14.5cm



SI-1185
Micro-Friedman
14cm



SI-1186
Micro-Friedman
15cm



SI-1187
Micro-Friedman
16cm



SI-1188
Kleinert-Kutz
18.5cm



SI-1189
Beyer
18.5cm



SI-1190
Mead 1A
18.5cm



SI-1191
Luer
18.5cm

EXTRACTING FORCEPS (English Pattern)

- Щипцы экстракционные (английская форма)
- Daviers (Forme Anglaise)
- Zahnzangen (Englische Form)
- Щипці екстракційні (англійська форма)
- Forceps de Extracción (Forme Inglesa)
- استخراج الملقط (نمط اللغة الإنجليزية)



SI-1192
Meissner
Extracting Forceps

SI-1193
Meissner
Extracting Forceps

SI-1194
Meissner
Extracting Forceps

SI-1195
Comellas Forceps
Anatomical Handle

DENTAL SYRINGES

- Шприцы стоматологические карпульные
- Шприці стоматологічні карпульні
- Seringues à usage dentaire
- Jeringas dentales
- Dentalspritzen
- المحاقن الأسنان



SI-1196 1.8ml
SI-1197 2.2ml



SI-1198 1.8ml
SI-1199 2.2ml



SI-1200 1.8ml
SI-1201 2.2ml



SI-1202 1.8ml
SI-1203 2.2ml



SI-1204 1.8ml
SI-1205 2.2ml



HI1206 1.8ml
SI-1207 2.2ml



SI-1208
1001
Intraligamental
Anesthesia
Syringe in
Black Colour



SI-1209 1.8ml
SI-1210 2.2ml
Angled



SI-1211
Aluminium - Dark 1.8 ml

- | | | | |
|---|---|--|---------------------------------------|
| | | | |
| SI-1212
Aluminium -
Silver 1.8 ml | SI-1213
Aluminium -
Orange 1.8 ml | SI-1214
Aluminium -
Green 1.8 ml | SI-1215
Aluminium -
Blue 1.8 ml |



Type C
SI-1216 1,8ml
SI-1217 2,2ml



Type C
SI-1218 1,8ml
SI-1219 2,2ml



2-Ring
SI-1220 1,8ml
SI-1221 2,2ml



Aspirating Syringe
SI-1222 1.8mm
SI-1223 2.2mm



Cartridge Syringe
SI-1224 1.8mm
SI-1225 2.2mm



Cartridge Syringe
SI-1226 1.8mm
SI-1227 2.2mm



Cartridge Syringe
SI-1228 1.8mm
SI-1229 2.2mm

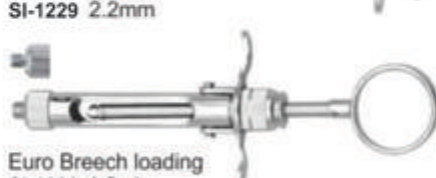

Euro Breech loading
SI-1230 1,8ml
SI-1231 2,2ml

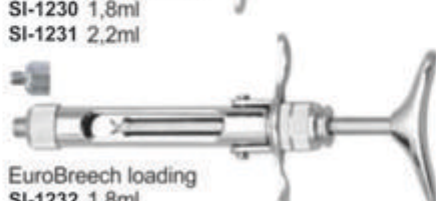

EuroBreech loading
SI-1232 1,8ml
SI-1233 2,2ml



Manual Aspirating Syringe
SI-1234 1,8ml
SI-1235 2,2ml



Quatro
SI-1236 1,8ml
SI-1237 2,2ml



Trio
SI-1238 1,8ml
SI-1239 2,2ml



Swedish Type
SI-1240 1,8ml
SI-1241 2,2ml



Ject Ultima
SI-1242 1,8ml
SI-1243 2,2ml
Injects 0,05 ml with every click Supplied with
angled and straight tubes



Ject angled
SI-1244 1,8ml
SI-1245 2,2ml

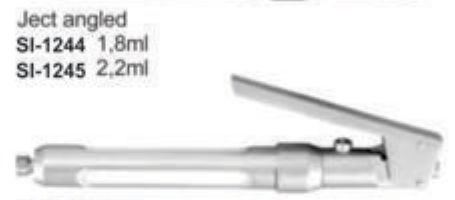

Ject straight
SI-1246 1,8ml
SI-1247 2,2ml



Disc System
SI-1248 1,8ml
SI-1249 2,2ml



Disc System
SI-1250 1,8ml

EXTRACTING FORCEPS SET

Извлечение щипцов
Ensemble de pinces d'extraction
• Zange sammeln

• Витягуючий комплект щипців
• Extracción del conjunto de fórceps
• استخراج ملقط مجموعة



SI-1251
Extracting Forceps
Set of 10 Pieces
Extracting Forceps Fig. 2
Extracting Forceps Fig. 7
Extracting Forceps Fig. 13
Extracting Forceps Fig. 17
Extracting Forceps Fig. 18
Extracting Forceps Fig. 22
Extracting Forceps Fig. 33
Extracting Forceps Fig. 51A
Extracting Forceps Fig. 67A
Extracting Forceps Fig. 79



SI-1252
Extracting Forceps
Set of 10 Pieces
Extracting Forceps Fig. 2
Extracting Forceps Fig. 7
Extracting Forceps Fig. 13
Extracting Forceps Fig. 17
Extracting Forceps Fig. 18
Extracting Forceps Fig. 22
Extracting Forceps Fig. 33
Extracting Forceps Fig. 51A
Extracting Forceps Fig. 67A
Extracting Forceps Fig. 79



SI-1253
Extracting Forceps
Set of 13 Pieces
Extracting Forceps Fig. 2
Extracting Forceps Fig. 7
Extracting Forceps Fig. 13
Extracting Forceps Fig. 17
Extracting Forceps Fig. 18
Extracting Forceps Fig. 22
Extracting Forceps Fig. 33
Extracting Forceps Fig. 51A
Extracting Forceps Fig. 67A
Extracting Forceps Fig. 79
Extracting Forceps Fig. 86C
Extracting Forceps Fig. 89
Extracting Forceps Fig. 90



SI-1254
Extracting Forceps Children Pattern
Set of 10 Pieces
Extracting Forceps Fig. 13S
Extracting Forceps Fig. 22S
Extracting Forceps Fig. 30S
Extracting Forceps Fig. 33S
Extracting Forceps Fig. 37
Extracting Forceps Fig. 38
Extracting Forceps Fig. 39
Extracting Forceps Fig. 39L
Extracting Forceps Fig. 39R
Extracting Forceps Fig. 51S



SI-1255
Extracting Forceps English adult Adult
Set of 10 Pcs



SI-1256
Extracting Forceps American Adult
Set of 10 Pcs



SI-1257
Extracting Forceps American Adult
Set of 8 Pcs



SI-1258
Extracting Forceps Pedro
Set of 7 Pcs

ROOT ELEVATOR

FUNCTION OF ROOT ELEVATORS IN SURGERY

To Loosen Tooth or Root From Bony Socket Prior to Placement of The Extraction Forceps.

HANDLES FOR ROOT ELEVATORS POINTS A, B, C, D, E, F, G, H



ROOT ELEVATOR

- Elevator корневой экстракционный
- Elévateurs à racines
- Wurzelheber
- Elevator корневий экстракційний
- Elevadores para raices
- المصاعد الجذر

Function of Root Elevators:

To loosen tooth or root from bony socket prior to placement of the extraction forceps.

Apexo Root Elevators



Luxator Root Elevators



Bein Root Elevators

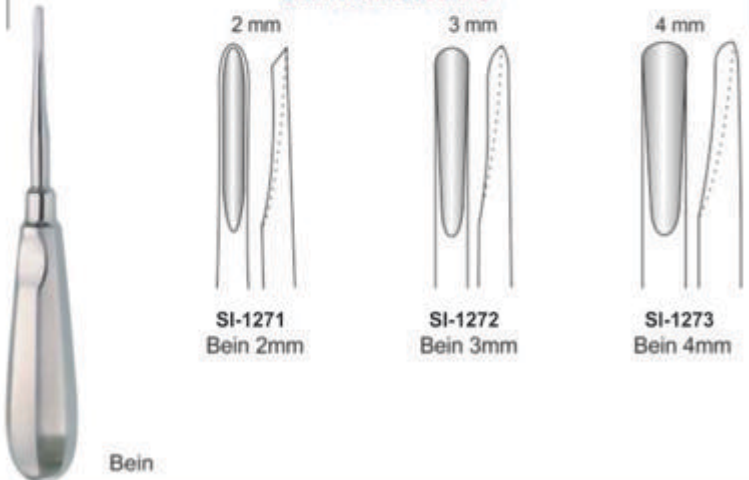

Seldin Root Elevators

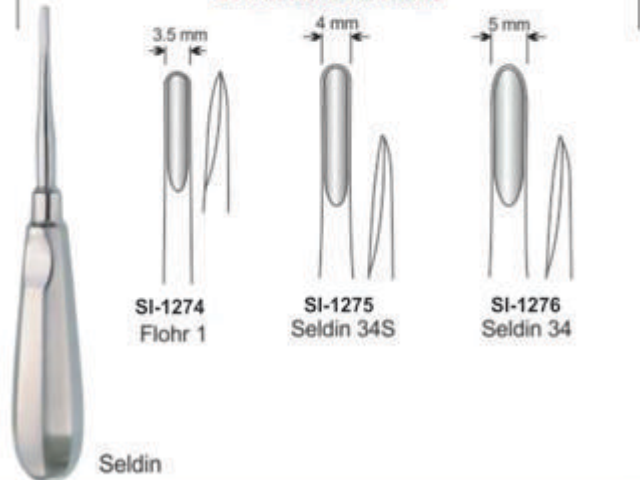

ROOT ELEVATOR

- Элеватор корневой экстракционный
- Elévateurs à racines
- Wurzelheber
- Слеватор корневий экстракційний
- Elevadores para raices
- المصاعد الجذر

FUNCTION: To loosen tooth or root from bony socket prior to placement of the extraction forceps.

Laxutor Root Elevators

Long Type



Laxutor
Root Elevator



SI-1277
Laxutor
1.5mm
Str.



SI-1278
Laxutor
2mm
Str.



SI-1279
Laxutor
3mm
Str.



SI-1280
Laxutor
5mm
Str.



SI-1281
Laxutor
3mm
Cvd.



SI-1282
Laxutor
5mm
Cvd.



SI-1283
Laxutor
3mm
Upper Angle



SI-1284
Laxutor
3mm
Double Angle



SI-1285
Laxutor
3mm
Str.



SI-1286
Laxutor
5mm
Str.



ROOT ELEVATOR

- Элеватор корневой экстракционный
- Elévateurs à racines
- Wurzelheber
- Слеватор корневий экстракційний
- Elevadores para raices
- المصاعد الجذر

Laxutor Root Elevators



lower roots elevator



Upper root elevator with helicoidal tip

Luxator Roots Elevator



Function of Root Elevators:

To loosen tooth or root from bony socket prior to placement of the extraction forceps.

Apical Root Elevators

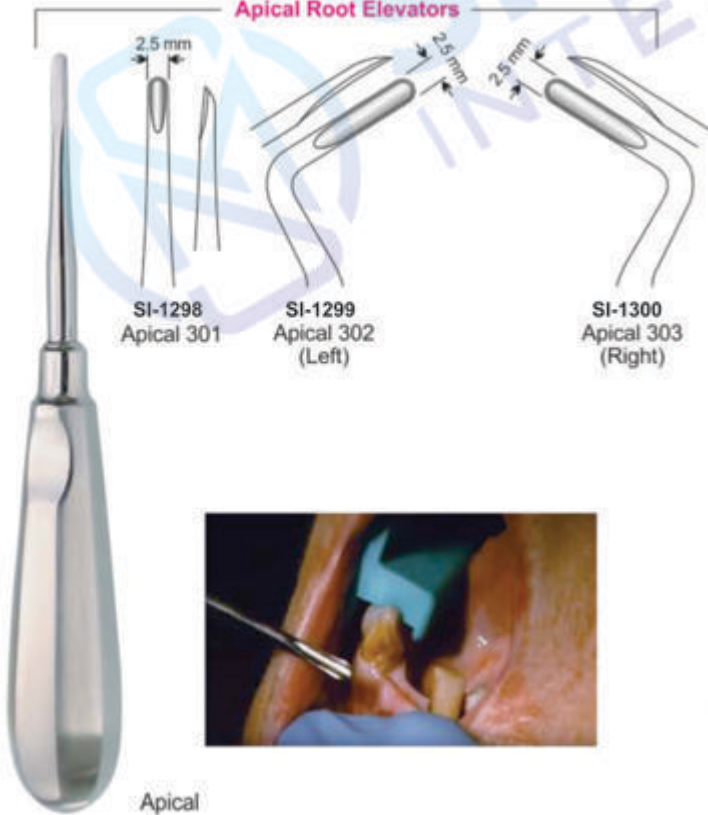

Apical Root Elevators

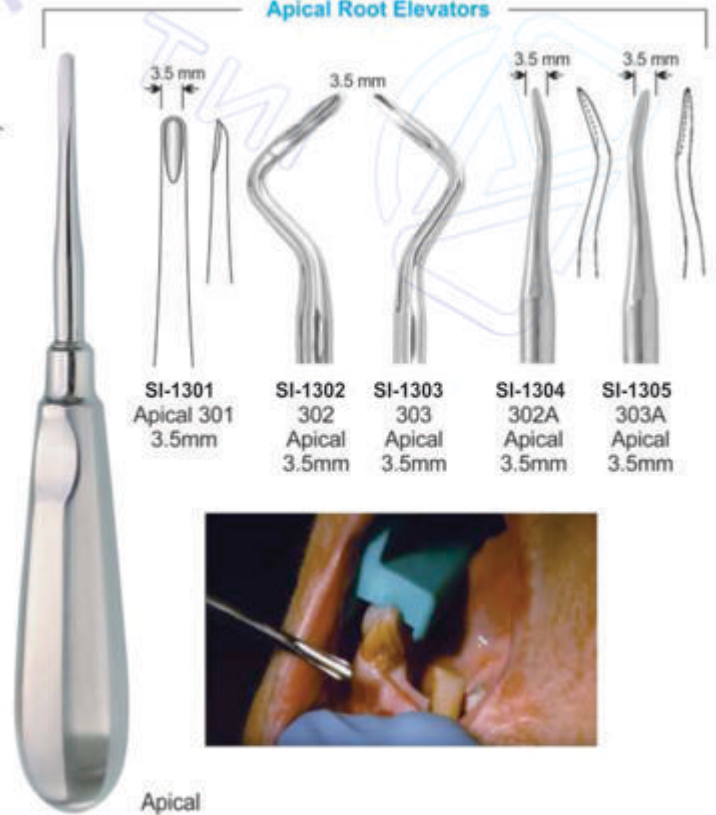

ROOT ELEVATOR

- Элеватор корневой экстракционный
- Elévateurs à racines
- Wurzelheber
- Слеватор корневий екстракційний
- Elevadores para raices
- المضاد الجذر

FUNCTION: To Loosen Tooth or Root From Bony Socket Prior to Placement of The Extraction Forceps.

Cryer Root Elevators



Seldin Root Elevators

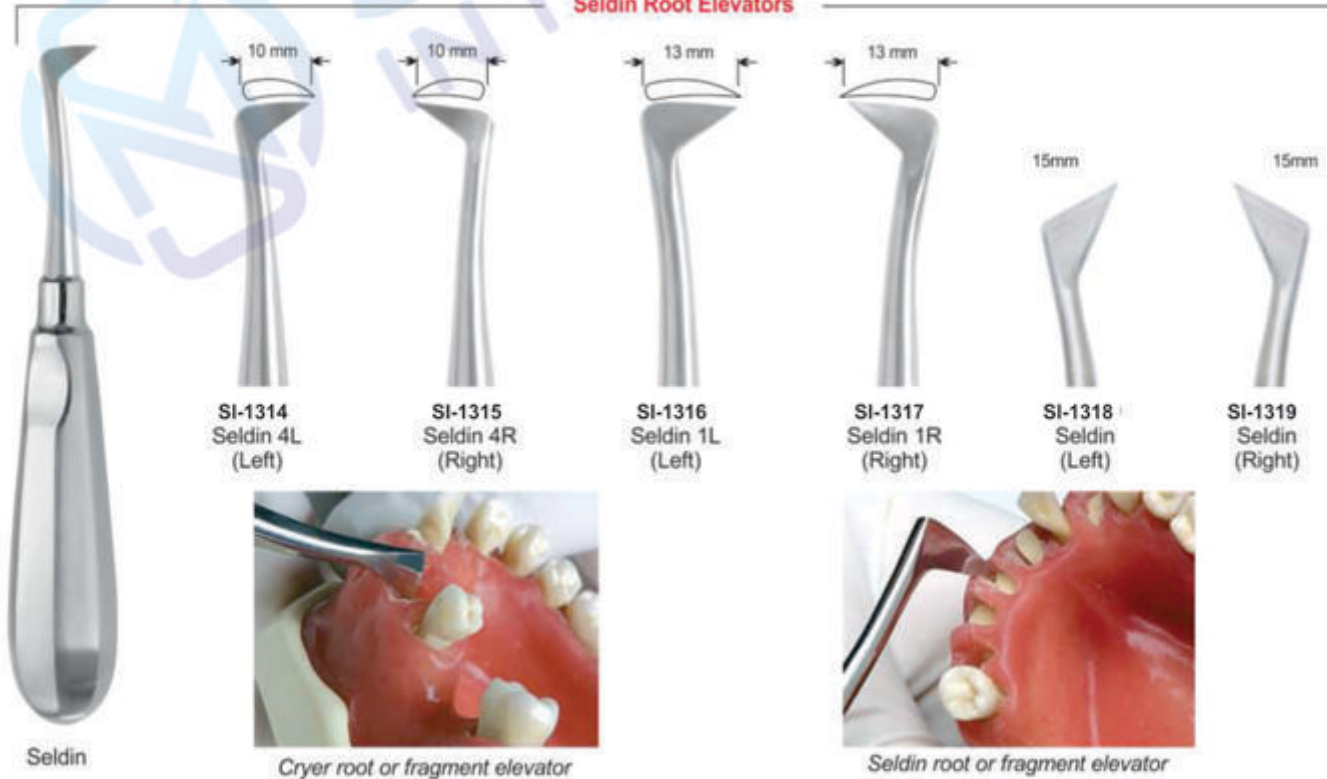

ROOT ELEVATOR

- Элеватор корневой экстракционный
- Elévateurs à racines
- Wurzelheber
- Слеватор корневий экстракційний
- Elevadores para raices
- المصاعد الجذر

FUNCTION: To Loosen Tooth or Root From Bony Socket Prior to Placement of The Extraction Forceps.

Apical Root Elevators

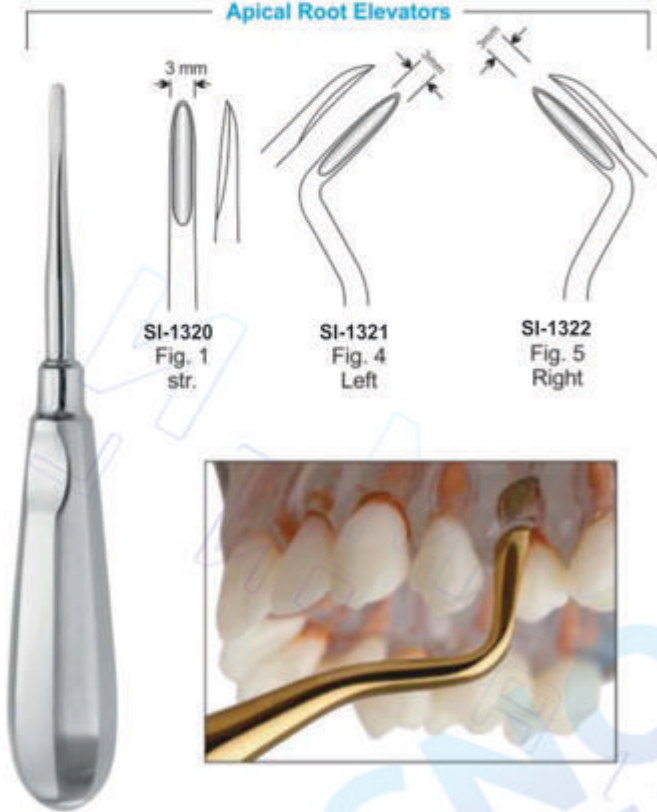

Apical Root Elevators

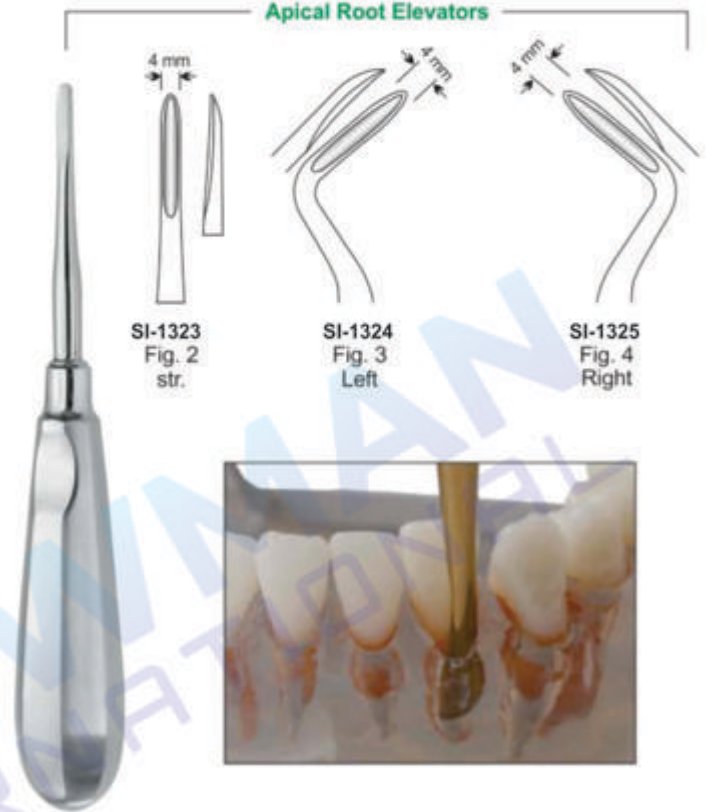

Flohr Root Elevators

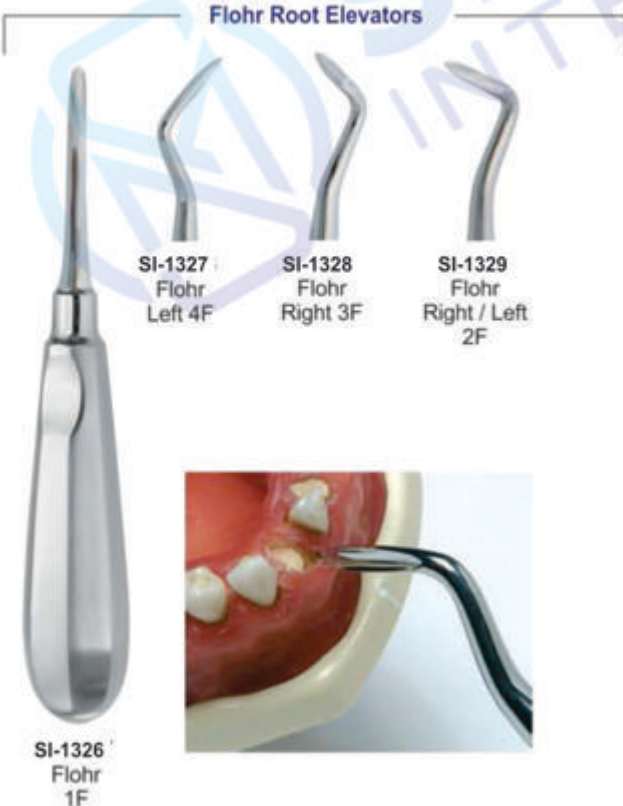

Heidbrink Root Elevators

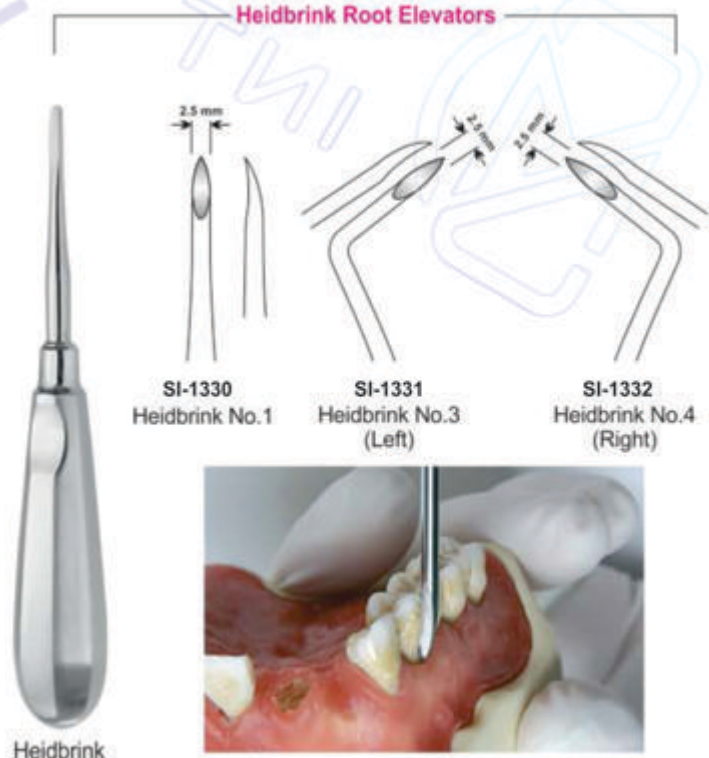

ROOT ELEVATOR

- Элеватор корневой экстракционный
- Elévateurs à racines
- Wurzelheber
- Слеватор корневий экстракційний
- Elevadores para raices
- المضاد الجذر

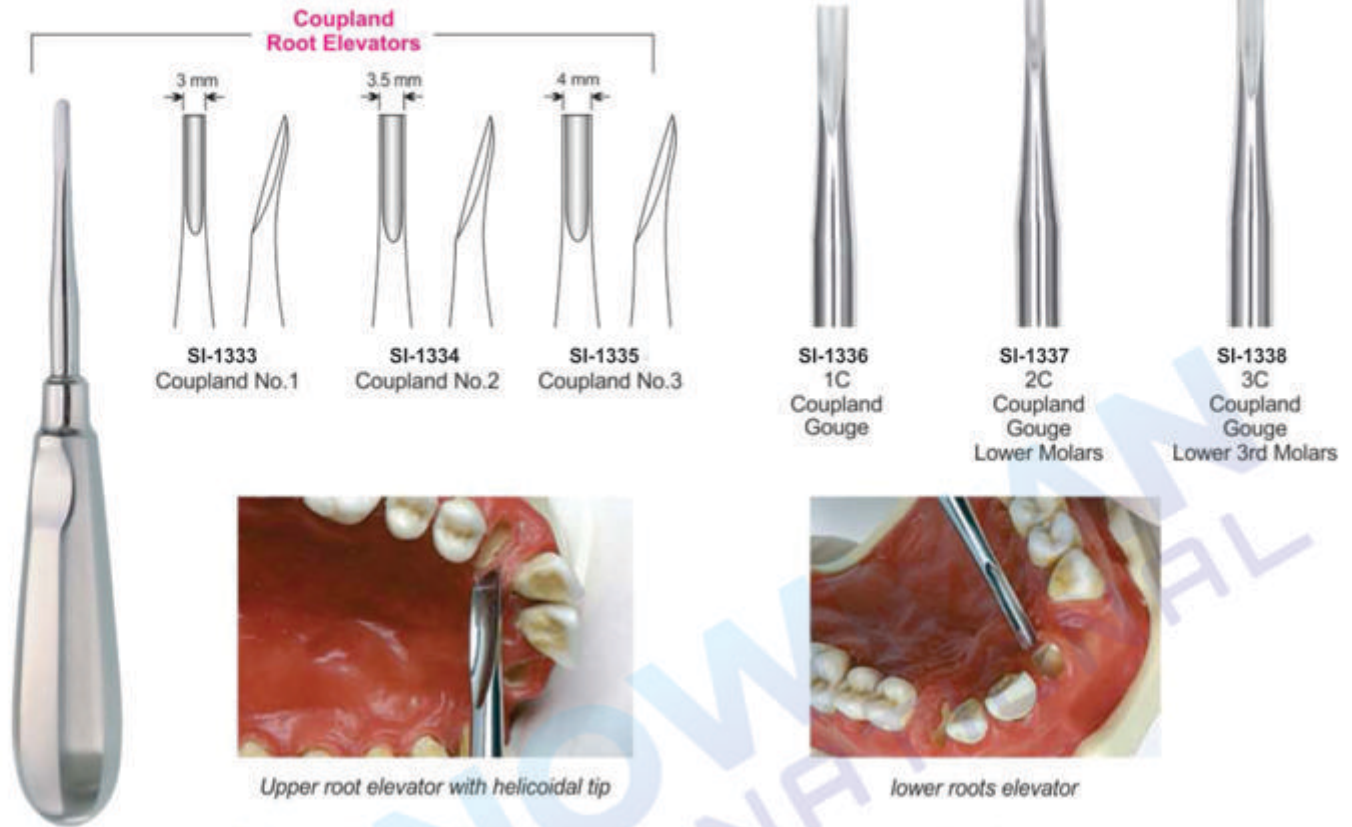

FUNCTION: To Loosen Tooth or Root From Bony Socket Prior to Placement of The Extraction Forceps.

ENGLISH PATTERNS



ROOT ELEVATOR

- Элеватор корневой экстракционный
- Elévateurs à racines
- Wurzelheber
- Слеватор корневий екстракційний
- Elevadores para raices
- المصاعد الجذر

Lindo Levian Root Elevators

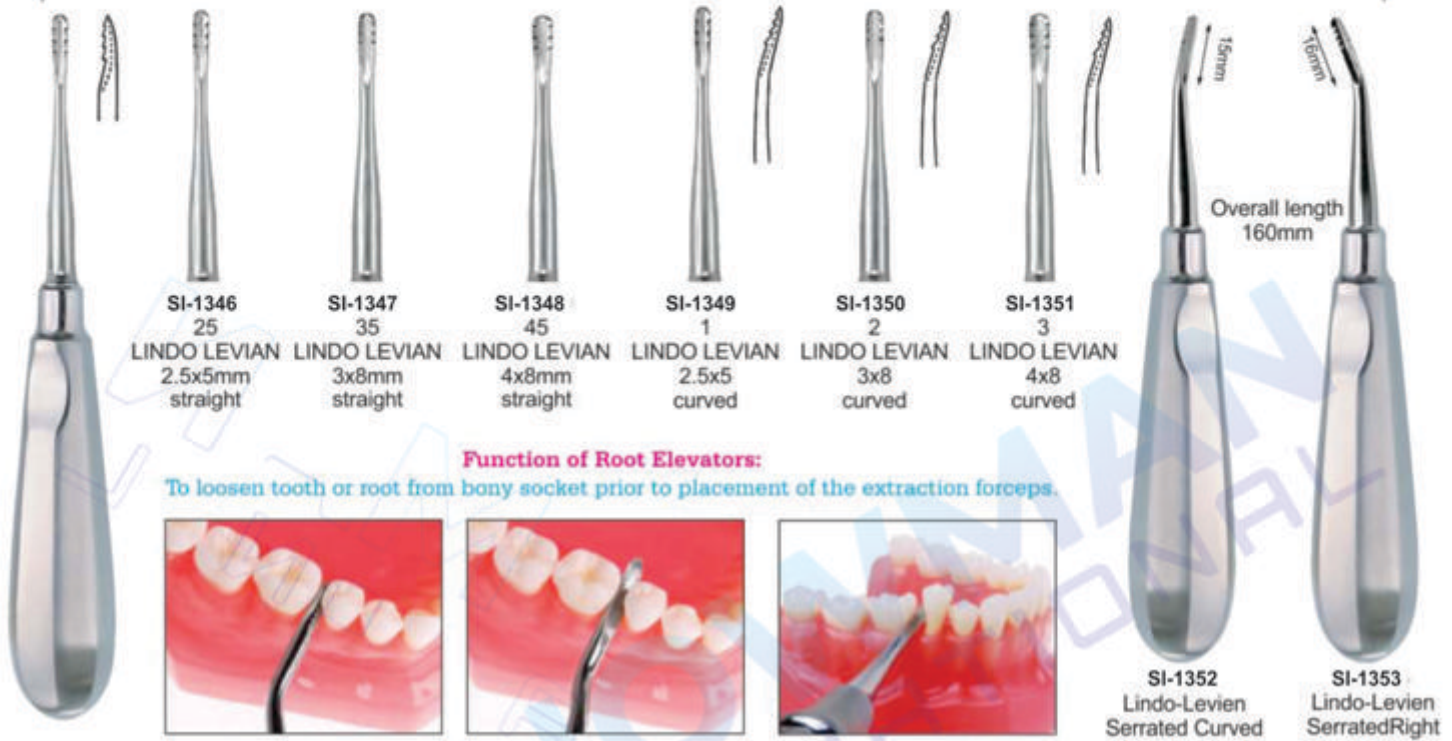

Function of Root Elevators:

To loosen tooth or root from bony socket prior to placement of the extraction forceps.



ROOT ELEVATOR

- Элеватор корневой экстракционный
- Elévateurs à racines
- Wurzelheber
- Слеватор корневий екстракційний
- Elevadores para raices
- المصاعد الجذر

Friedmann Roots Elevator



HI1361
Friedmann 4F
Str.

SI-1362
Friedmann 5F
Left

HI1363
Friedmann 6F
Right

Luxating Elevator With Periotome Tip



SI-1364
3mm Luxating
Elevator / Periotome

SI-1365
4mm Luxating
Elevator / Periotome

SI-1366
5mm Luxating
Elevator / Periotome

Wisdom Roots Elevator



SI-1367
Wisdom
for 18 and 38

SI-1368
Wisdom
for 28 and 48

Function of Root Elevators: To loosen tooth or root from bony socket prior to placement of the extraction forceps.

Bayonet Roots Elevator Set



SI-1369
Left

SI-1370
Right

SI-1371
bayonet

SI-1372
Curved

SI-1373
Straight

ROOT ELEVATOR

- Элеватор корневой экстракционный
- Слеватор корневий екстракційний
- Elévateurs à racines
- Elevadores para raíces
- Wurzelheber
- المصاعد الجذر

Miller Root Elevators



Function of Root Elevators: To loosen tooth or root from bony socket prior to placement of the extraction forceps.

Claw-Lift Roots Elevator

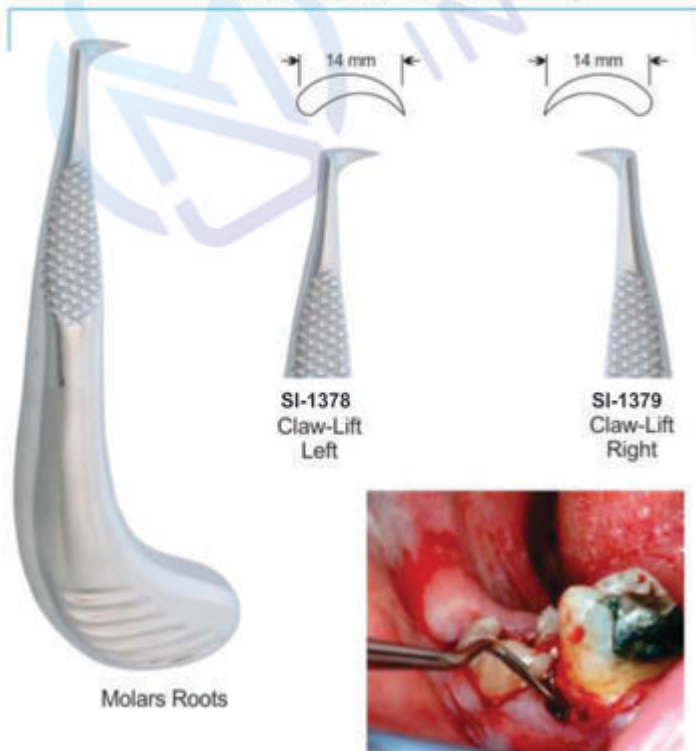

Schlemmer Roots Elevator



ROOT ELEVATOR

- Элеватор корневой экстракционный
- Elévateurs à racines
- Wurzelheber
- Слеватор корневий екстракційний
- Elevadores para raices
- المصاعد الجذر

FUNCTION: To Loosen Tooth or Root From Bony Socket Prior to Placement of The Extraction Forceps.

Laxutor Root Elevators Set of 9 Pcs



SI-1383
2mm Str.



SI-1384
3mm Str.



SI-1385
5mm Str.



SI-1386
3mm Cvd.



SI-1387
5mm Cvd.



SI-1388
3mm Angle



SI-1389
3mm Angle



SI-1390
3mm Str.



SI-1391
5mm Str.

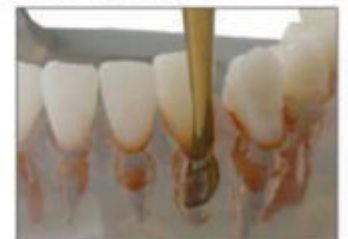

ROOT ELEVATOR

- Элеватор корневой экстракционный
- Elévateurs à racines
- Wurzelheber
- Слеватор корневой экстракційний
- Elevadores para raices
- المصاعد الجذر

Hylin Roots Elevator



Function of Root Elevators: To loosen tooth or root from bony socket prior to placement of the extraction forceps.

Kopp Roots Elevator

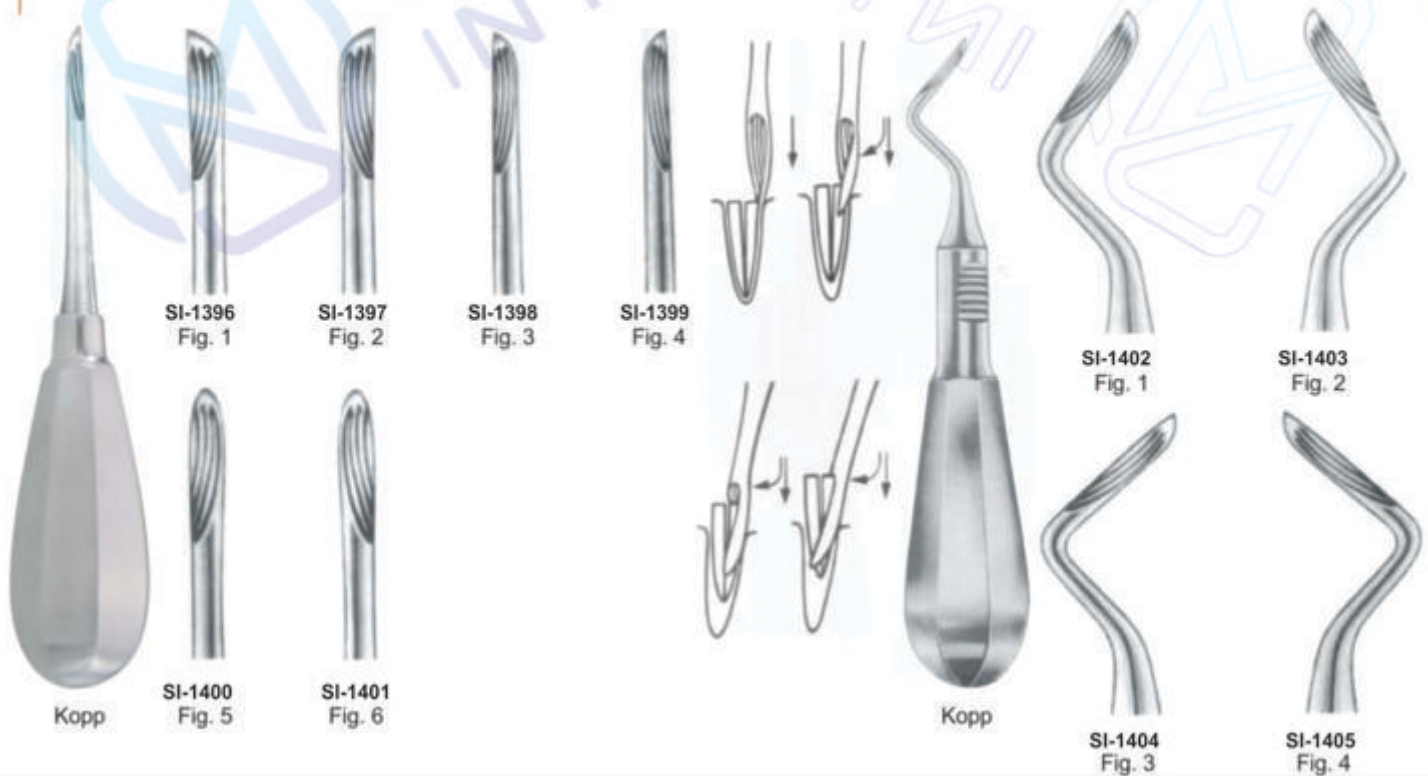

ROOT ELEVATOR

- Элеватор корневой экстракционный
- Elévateurs à racines
- Wurzelheber
- Слеватор корневий екстракційний
- Elevadores para raices
- المصاعد الجذر

Luxier Roots Elevator



SI-1406
Luxier
Cvd.

SI-1407
Luxier
Str.

Heber Roots Elevator



SI-1408
Heber
Bayonet

SI-1409
Heber
Bayonet

Bein Roots Elevator



SI-1410
Bein,
3mm

SI-1411
Bein,
4mm

Function of Root Elevators: To loosen tooth or root from bony socket prior to placement of the extraction forceps.

Bein Roots Elevator



ROOT ELEVATOR

- Элеватор корневой экстракционный
- Elévateurs à racines
- Wurzelheber
- Слеватор корневий экстракційний
- Elevadores para raices
- المصاعد الجذر

W. Barry Roots Elevator



W. Barry
Fig. 1
(125mm)



SI-1424
W. Barry
Fig. 1



SI-1425
W. Barry
Fig. 2



SI-1426
W. Barry
Fig. 3



SI-1427
W. Barry
Fig. 4



Function of Root Elevators: To loosen tooth or root from bony socket prior to placement of the extraction forceps.



SI-1428
Winter
Fig. 1L

Winter
Fig. 1L
125mm



SI-1429
Winter
Fig. 1R



SI-1430
775/3
Winter
11 L



SI-1431
775/4
Winter
11 R



SI-1432
775/5
Winter
12 L



SI-1433
775/6
Winter
12 R



SI-1434
775/7
Winter
13 L



SI-1435
775/8
Winter
13 R



SI-1436
Winter
Fig. 1L



SI-1437
Winter
Fig. 1R



SI-1438
Lecluse
bayonet



SI-1439
Potts "T-Handle"
Elevator-Left



SI-1440
Potts "T-Handle"
Elevator-Right

ROOT ELEVATOR

- Elevator корневой экстракционный
- Elévateurs à racines
- Wurzelheber
- Elevator корневой экстракційний
- Elevadores para raices
- المضاد الجذر



SI-1441
Fig. 1
Chompret



SI-1442
Fig. 2
Chompret



SI-1443
Fig. 3
Chompret



SI-1444
Fig. 4
Chompret



Lecluse elevator for lower third molar dislocation



Chompret syndesmotome, sickle pattern



SI-1445



SI-1446



SI-1447



SI-1448



SI-1449



SI-1450



SI-1451

Root Pick Elevator With Gold Flexible Points

ROOT ELEVATOR

- Элеватор корневой экстракционный
- Elévateurs à racines
- Wurzelheber
- Слеватор корневий екстракційний
- Elevadores para raices
- المصاعد الجذر

Heidbrink Roots Elevator



SI-1452
Heidbrink
Straight

SI-1453
Heidbrink
Left

SI-1454
Heidbrink
Right

SI-1455
Heidbrink
Straight

SI-1456
Heidbrink
Left

SI-1457
Heidbrink
Right

Syndesmotomes Roots Elevator



SI-1458
Straight

SI-1459
Left

SI-1460
Right

Periotome Roots Elevator



SI-1461
Periotome
2.1mm
Straight

SI-1462
Periotome
2.6mm
Straight

SI-1463
Periotome
2.1mm
Angular

SI-1464
Periotome
2mm
Curved

SI-1465
Periotome
2.0mm

SI-1466
Periotome
2.5mm

SI-1467
Periotome
3.0mm

SI-1468
Periotome
4.0mm

Syndesmotomes

ROOT ELEVATOR

- Элеватор корневой экстракционный
- Elévateurs à racines
- Wurzelheber
- Слеватор корневий екстракційний
- Elevadores para raices
- المصاعد الجذر

FUNCTION: To loosen small root fragments from bony socket

Heidbrink Roots Elevator

Warwick-James

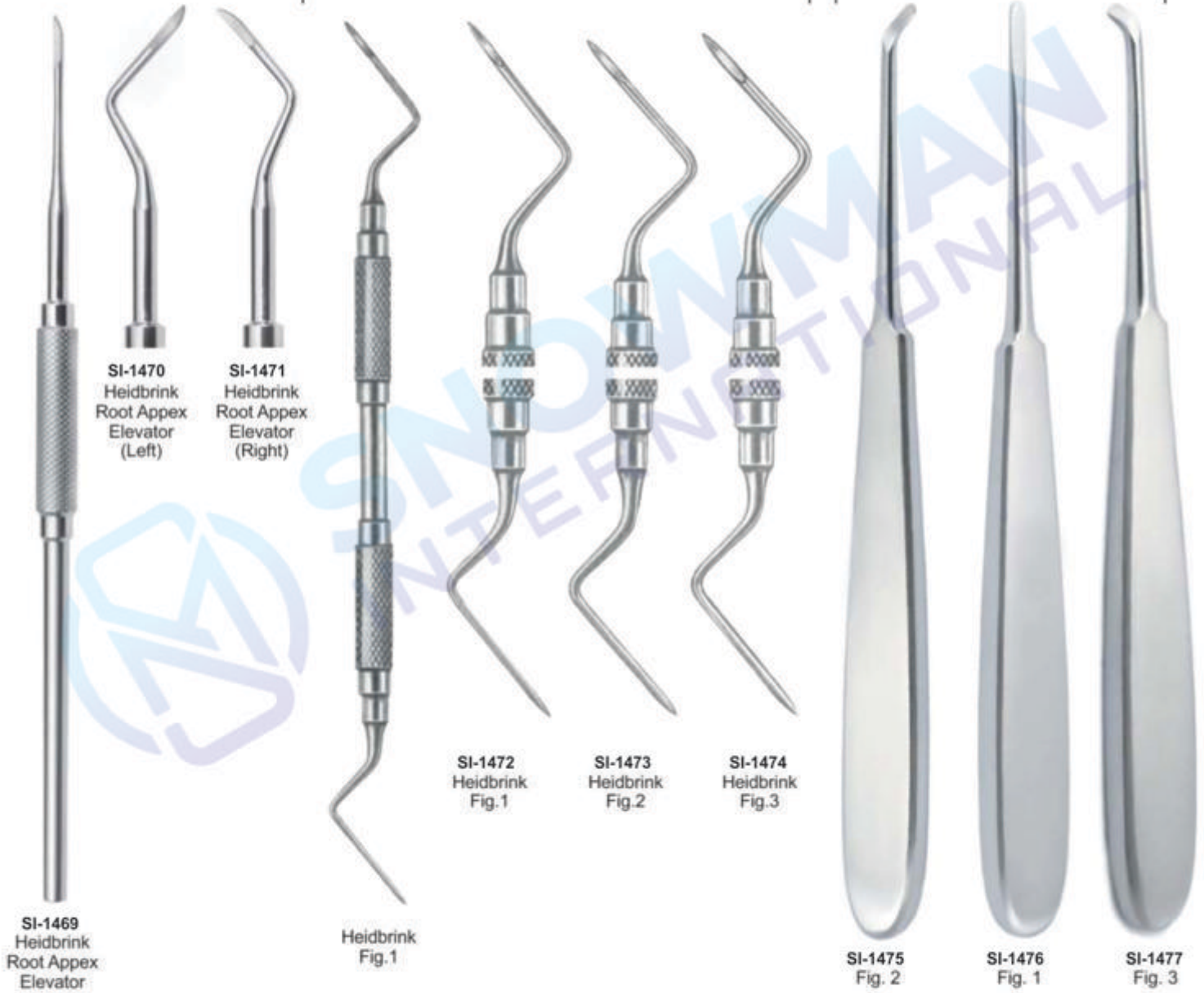

ROOT ELEVATOR

- Элеватор корневой экстракционный
- Elévateurs à racines
- Wurzelheber
- Слеватор корневий екстракційний
- Elevadores para raices
- المصاعد الجذر



SI-1478
1S
(Straight 1mm)



SI-1479
2S
(Straight 2mm)



SI-1480
3S
(Straight 3mm)



SI-1481
5S
(Straight 5mm)



SI-1482
3C
(Curved 3mm)



SI-1483
5C
(Curved 5mm)



SI-1484
3CA
(Curved Angle 3mm)



SI-1485
3IC
(Inverted Curved 3mm)



SI-1486
DE 3
(Dual Edge 3mm / 1.5mm)



SI-1487
DE 5
(Dual Edge 5mm / 3mm)

ROOT ELEVATOR

- Элеватор корневой экстракционный
- Elévateurs à racines
- Wurzelheber
- Слеватор корневий екстракційний
- Elevadores para raices
- المصاعد الجذر



SI-1488
Luxators Set of 7 Pcs

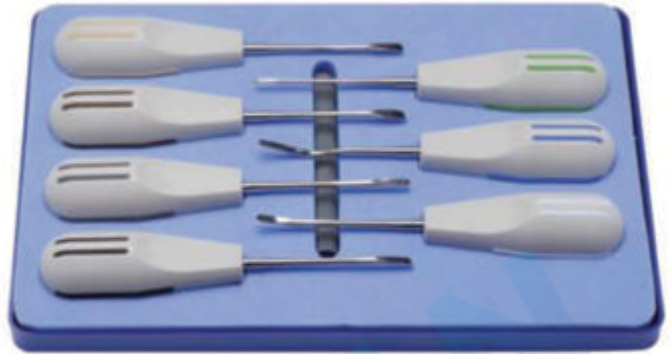

SI-1489
Luxators Set of 7 Pcs



SI-1490
Luxators Set of 8 Pcs



SI-1491
Root Elevators Set of 10 Pcs



SI-1492
Elevators Set of 8 Pcs



SI-1493
Elevators Set of 8 Pcs

ROOT ELEVATOR

- Элеватор корневой экстракционный
 - Élévateurs à racines
 - Wurzelheber
- Elevator corneviu extracționiu
 - Elevadores para raices
 - المصاعد الجذر

PDL ELEVATORS

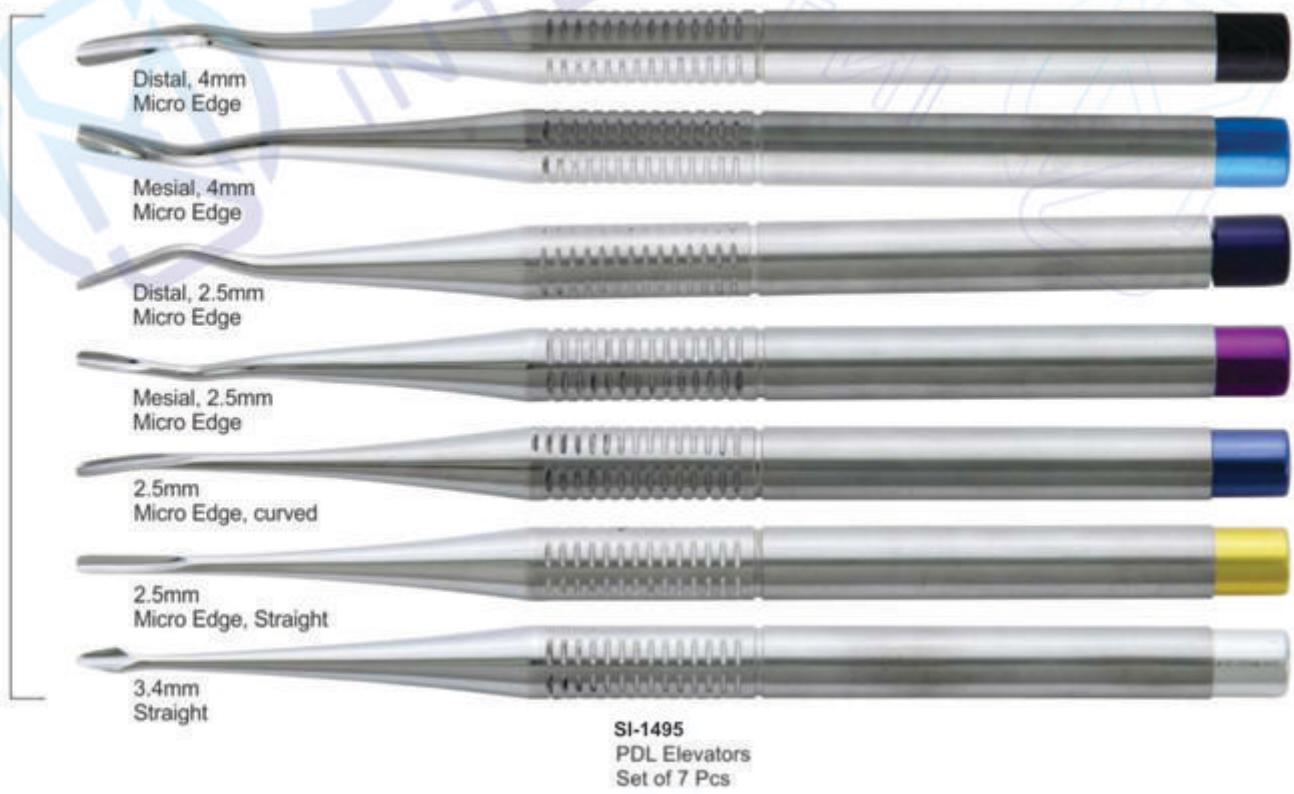

ROOT ELEVATOR

- Элеватор корневой экстракционный
- Elévateurs à racines
- Wurzelheber
- Слеватор корневий екстракційний
- Elevadores para raices
- المضاد الجذر

PDL ELEVATORS

Delicate Arrow tip



4,0mm straight
4,0mm curved

Luxivators straight
atraumatic luxation of the tooth



2,5mm straight
3,5mm straight
4,5mm straight

Luxivators curved
atraumatic luxation of the tooth



2,5mm curved
3,5mm curved
4,5mm curved



SI-1496
PDL Elevators
Set of 8 Pcs

Our Scalers

Compare our scalers and curettes with the best in the industry and you will immediately recognize we are equal in every way but one... price. Note the deep precision knurling for better tactile feel. The same high-grade stainless steel tips, the same light weight (under 18 grams) for less hand fatigue, the same professional craftsmanship, and surpassing the highest industry standards. of course, any manufacturer can make these claims, but we guarantee and certify ours.

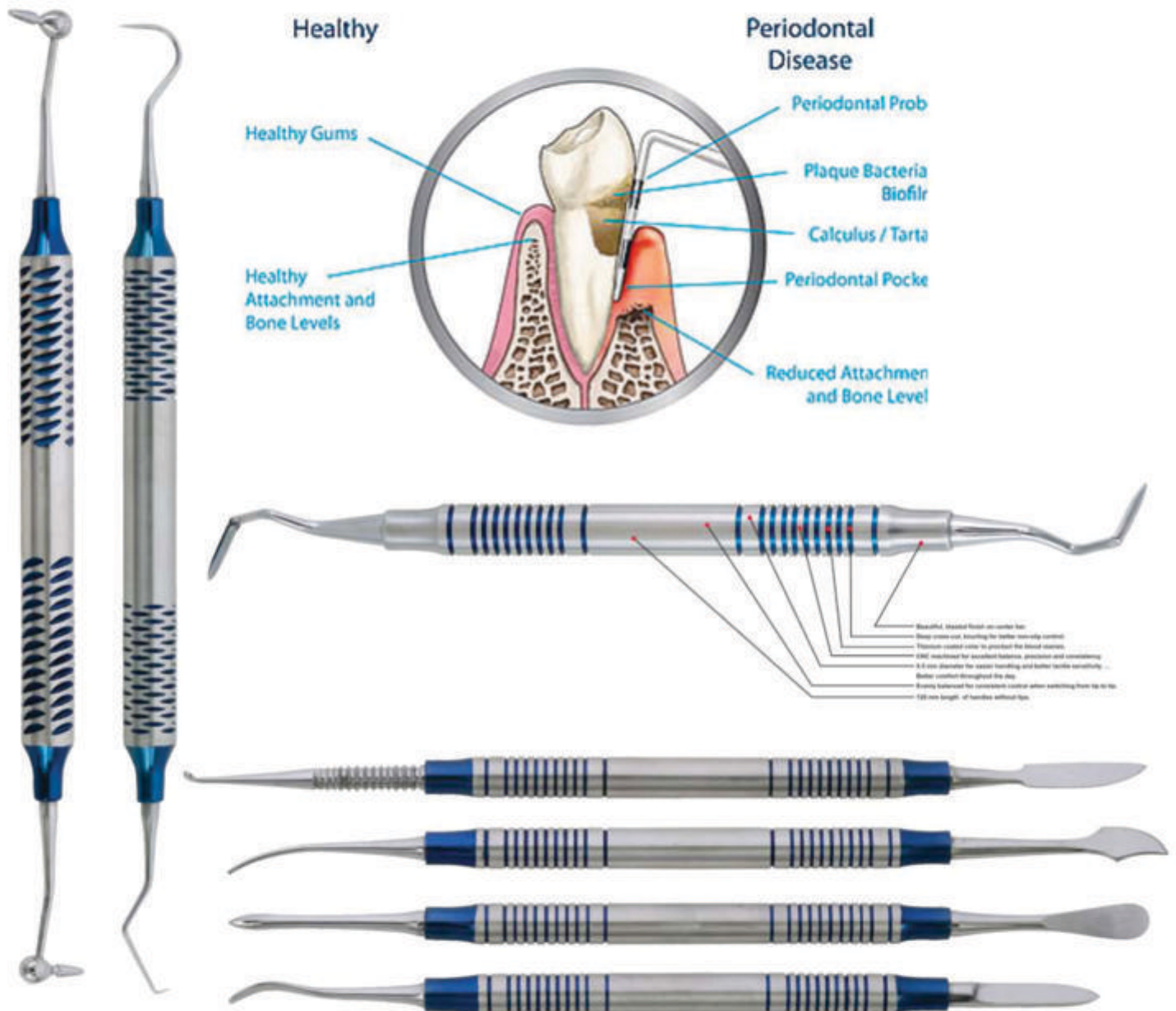

- High-polish mirror finish tips.
- Manufactured within the guidelines of the FDA quality assurance system for good manufacturing practices.
- Highest grade German stainless steel, razor sharp, durable tips. Rockwell hardened to 60 RHc.
- 27 of the most popular designs from graces to McCallis to columbias, and many european patterns.
- All instruments are guaranteed against defects in material and workmanship.

- All instruments bear the ce mark, emblematic of the european community's highest standards.
- Customer satisfaction guarantee, too!
- Less than 20 grams ... Lightweight for less hand fatigue.
- Manufactured to the most exacting standards so the 50th instrument you buy is exactly like your first.
- You decide ... Why pay more for the same high-quality instruments?

VALUED BUYERS

Compare our scalers and curettes with the best in the industry and you will immediately recognize we are equal in every way but one... price. Note the deep precision knurling for better tactile feel. The same high-grade stainless steel tips, the same light weight (under 20 grams) for less hand fatigue, the same professional craftsmanship, and surpassing the highest industry standards. Of course, any manufacturer can make these claims, but we guarantee and certify ours. We regularly manufacturing below articles in showing handles & pattern A to L for better grip & perfection. We are also fully equipped & capable to develop these instruments as per your own specific requirements & demands in materials, sizes, shapes and patterns.



A-Hollow Handle Ø 10 mm



B-Hollow Handle Ø 10 mm



C-Hollow Handle Ø 10 mm



D-Hollow Handle Ø 10 mm



E-Hollow Handle Ø 10 mm



F-Hollow Handle Ø 10 mm



G-Hollow Handle Ø 10 mm



H-Hollow Handle Ø 6.4 mm



I-Hollow Handle Ø 8 mm



J-Hollow Handle Ø 10 mm



K-Soild Handle Ø 6 mm



L-Soild Handle Ø 6 mm

MOUTH MIRRORS

- зеркала
- Espejos de la boca
- Mundspiegel
- дзеркала
- Miroirs à la bouche
- مرآيا الفم

Plain



SI-1497 Fig. 3 Ø20mm
 SI-1498 Fig. 4 Ø22mm
 SI-1499 Fig. 5 Ø24mm
 SI-1500 Fig. 6 Ø26mm



Cone-Socket Plain



SI-1511 Fig. 3 Ø20mm
 SI-1512 Fig. 4 Ø22mm
 SI-1513 Fig. 5 Ø24mm

Magnifying



SI-1501 Fig. 3 Ø20 mm
 SI-1502 Fig. 4 Ø22 mm
 SI-1503 Fig. 5 Ø24 mm



Cone-Socket Magnifying



SI-1514 Fig. 3 Ø20mm
 SI-1515 Fig. 4 Ø22mm
 SI-1516 Fig. 5 Ø24mm

Rhodium



SI-1504 Fig. 3 Ø20mm
 SI-1505 Fig. 4 Ø22mm
 SI-1506 Fig. 5 Ø24 mm



Cone-Socket Rhodium



SI-1517 Fig. 3 Ø20mm
 SI-1518 Fig. 4 Ø22mm
 SI-1519 Fig. 5 Ø24mm

Front Surface



SI-1507 Fig. 3 Ø20mm
 SI-1508 Fig. 4 Ø22mm
 SI-1509 Fig. 5 Ø24mm
 SI-1510 Fig. 6 Ø26mm



Cone-Socket Front Surface



SI-1520 Fig. 3 Ø20mm
 SI-1521 Fig. 4 Ø22mm
 SI-1522 Fig. 5 Ø24mm

HANDLES FOR MOUTH MIRRORS

- Ручки для зеркал
- Manches pour miroirs à bouche
- Mundspiegelgriffe
- Ручки для дзеркал
- Mangos para espejos de boca
- مقابض لمرآة الفم



SI-1523
Hollow Mirror
Handle Round
Ø 10 mm



SI-1524
Hollow Mirror
Hexagonal
Handle
Ø 8 mm



SI-1525
Hollow
Ø 8 mm



SI-1526
Hollow Mirror
Hexagonal
Handle
Ø 10 mm



SI-1527
Hollow Mirror
Handle
Ø 8 mm



SI-1528
Hollow Mirror
Handle
Ø 10 mm



SI-1529
Mirror Handle
Solid
Ø 6 mm



SI-1530
Mirror Handle
Solid
Ø 6 mm



SI-1531
Mirror Handle
Solid Octagonal
Ø 6 mm



SI-1532
Mirror Handle
Stem
with Rule
35mm



SI-1533
Mirror Handle
Solid
Stem with
Rule 35mm



SI-1534
Cone-Socket
Solid Octagonal
Ø 6 mm



SI-1535
Cone-socket
Solid
Ø 6 mm



SI-1536
Cone-socket
Hexagonal
Handle
Ø 6 mm

Cone-Socket Mirror Handle

EXPLORERS

- Зонды
 - Sondes
 - Zahnsonden
- Зонди
 - Sondas
 - المستكشفين

Examination kit Set of 3 Pieces



SI-1537 Probe
HIR-1538 Mirror
SI-1539 College Forcep 15cm



Examination Set of 4 Pieces



SI-1540 : Exp,23/17-A
SI-1541 Exavators
SI-1542 Tweezers
SI-1543 Mouth Mirror

SI-1544

First Aid Examination Set of 3 Pieces



SI-1545

First Aid Examination Set of 3 Pieces



SI-1546

First Aid Examination Set of 3 Pieces



SI-1547

First Aid Examination Set of 3 Pieces



TWEEZERS

- Пинцеты
- Précelles - Brucelles
- Zahnpinzetten

- Пинцети
- Pinzas para algodón
- ملاقط



SI-1548
Surgical
11.5cm



SI-1549
London College
15cm



SI-1550
Semken Taylor
Str.



SI-1550
Semken Taylor
Cvd.



SI-1551
Meriam
16cm



SI-1552
Dressing
14cm



SI-1553
Semken Taylor
1x2 Straight



SI-1554
Semken Taylor
1x2 Curved



SI-1555
Gilles
15cm 1x2



SI-1556
Perry
13cm



SI-1557
Atraumatic
15cm Cvd



SI-1558
Atraumatic
15cm Str.



SI-1559
College with Lock
15cm Cvd.



SI-1560
Gerald
17.5cm



SI-1561
with lock
15cm



SI-1563
Atraumatic
17.5cm

TWEEZERS

- Пинцеты
- Précelles - Brucelles
- Zahnpinzetten

- Пинцети
- Pinzas para algodón
- ملاقط



SI-1566
Adson-TC
12cm



SI-1567
Adson-TC
12cm 1x2



SI-1568
Adson-TC
15cm 1x2



SI-1569
Adson
12cm



SI-1570
Adson
12cm 1x2



SI-1571
Adson
15cm 1x2



SI-1572
Adson Brown
12cm



SI-1573
Crane Kaplan
15cm



SI-1574
Crane Kaplan
15cm



SI-1575
Crane Kaplan
15cm



SI-1576
Hemingway
15cm



SI-1577
Miller
15cm Str.



SI-1578
Miller
15cm Cvd.



SI-1579
Dressing
Tweezer
14.5cm



SI-1580
College
Curved
Tip 15cm



SI-1581
Maryam
Tweezers
15cm



SI-1582
College
Tweezer
15cm



SI-1583
Perry
Tweezer
12.5cm



SI-1584
Self-locking
Tweezer
15cm

EXPLORERS

- Зонды
- Sondes
- Zahnsonden
- Зонди
- Sondas
- المستكشفين

Single Ended Probe Solid Handle 4.5mm Length 150mm



SI-1585
Fig. 2

SI-1586
Fig. 23

SI-1587
Fig. 9

SI-1588
Fig. 16

SI-1589
Fig. 11

SI-1590
Fig. 03

SI-1591
Fig. 3A

SI-1592
Fig. 5

SI-1593
Fig. 6

SI-1594
Fig. 8

SI-1595
Fig. 8A

SI-1596
Fig. 10

SI-1597
Fig. 12

SI-1598
Fig. 17

SI-1599
Fig. 17A

Fig. 2 Normal Handle
Fig. 2 Anatomic Handle

Explorers-Single-End

Double-Ended Explorers



EXPLORERS

- Зонды
 - Sondes
 - Zahnsonden
- Зонди
 - Sondas
 - المستكشفين

Probes Double Ended 6mm, length 170mm

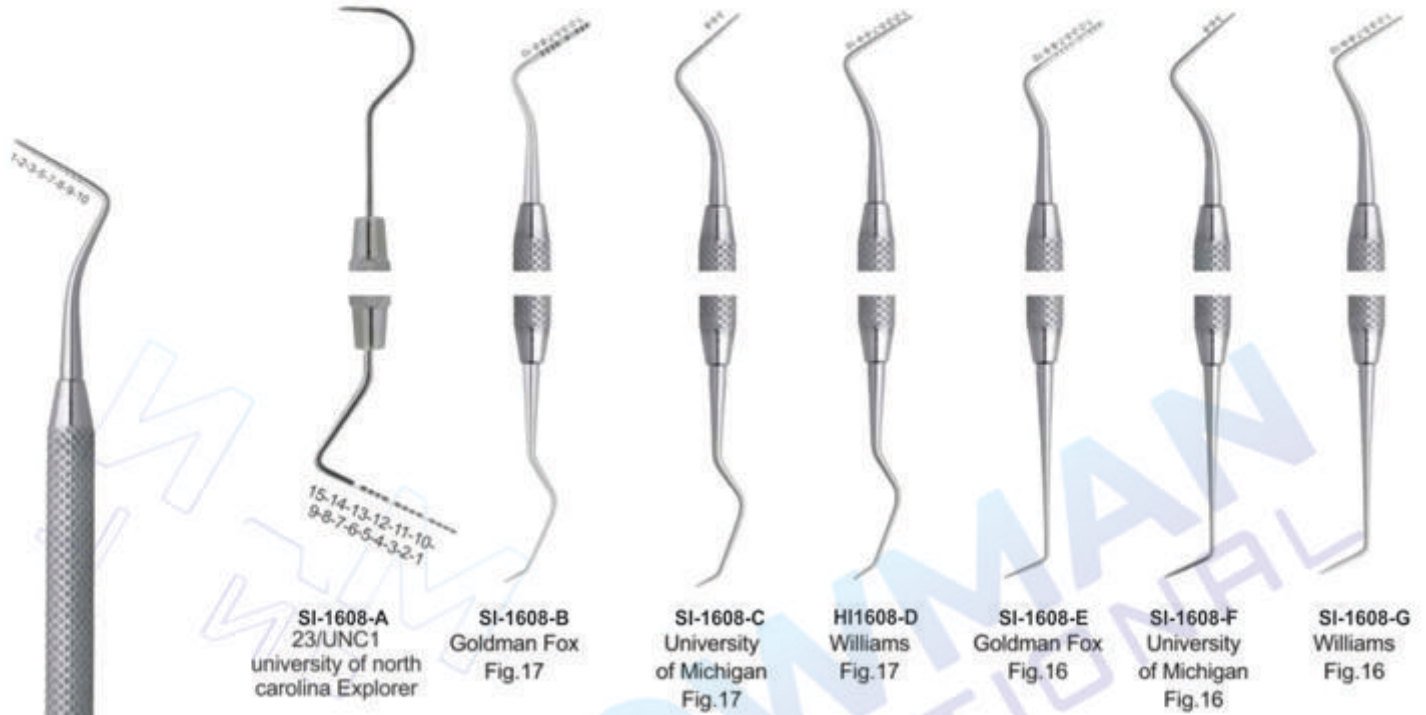

Pointed Probes Double Ended Handle 6mm, length 170mm



SI-1608
Williams

EXPLORERS

- Зонды
- Sondes
- Zahnsonden
- Зонди
- Sondas
- المستكشفين

EXPLORERS INSTRUMENTS SOLID HANDLE 6MM, LENGTH 170MM

PLUGGERS

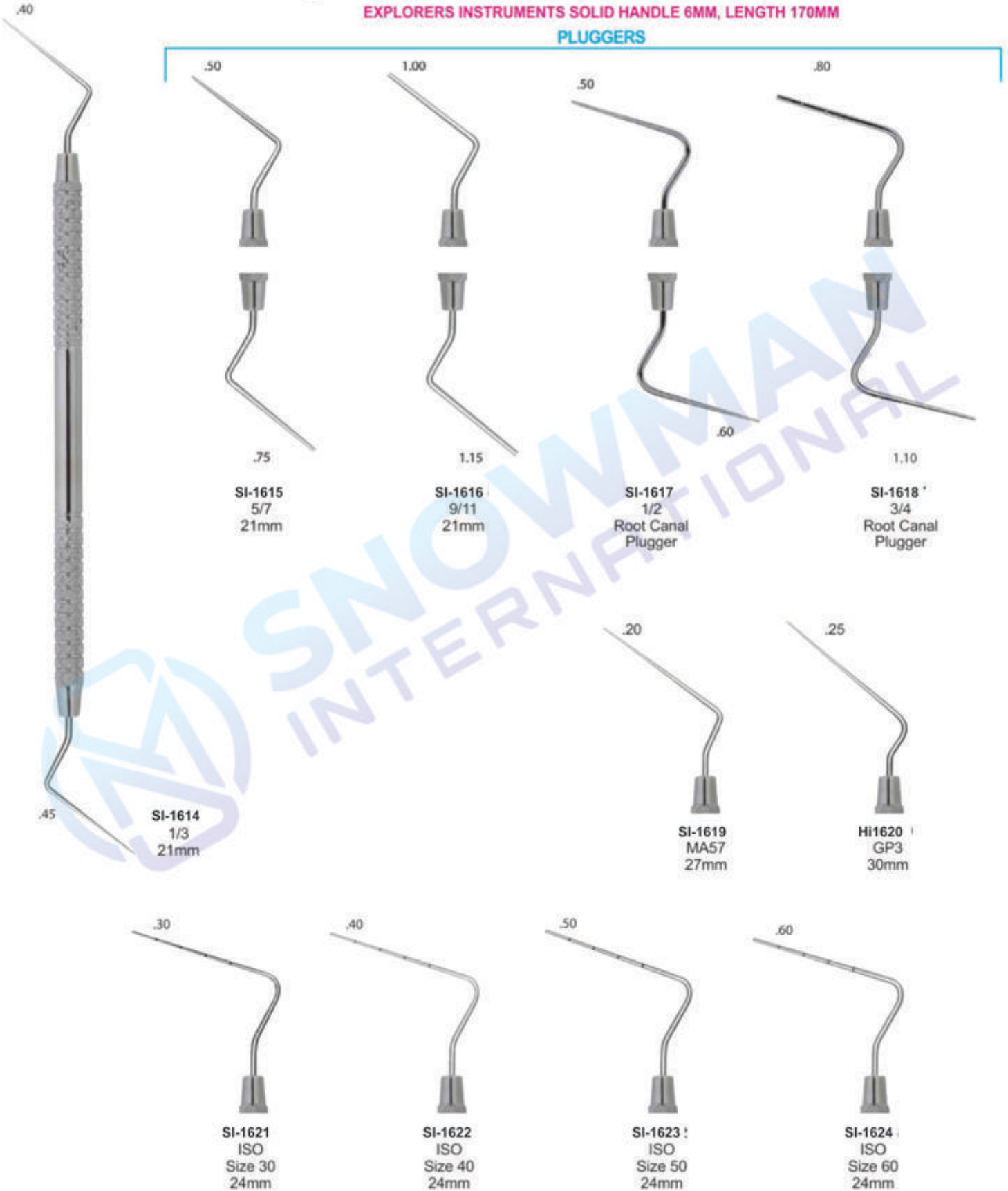

PERIODONTAL PROBES

- Зонды пародонтологические
 - Sondes paradontales
 - sonda parodontali
- зонди пародонтологічні
 - Sondas paradontales
 - المسابير اللثة

SPREADERS

HEAT CARRIERS

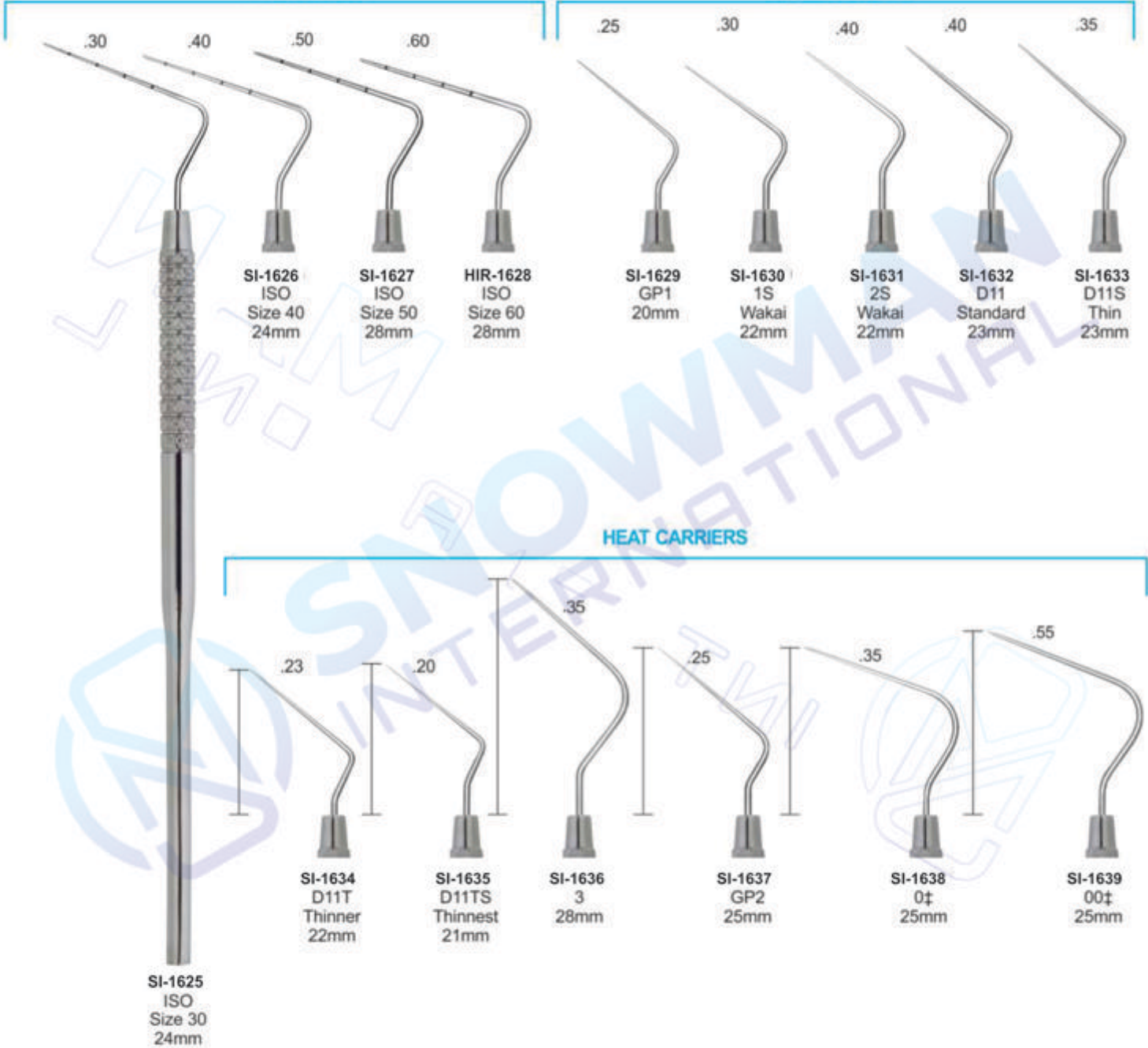

PERIODONTAL PROBES

- Зонды пародонтологические
- Sondes paradontales
- sonda paradontali
- зонди пародонтологічні
- Sondas paradontales
- المسابر اللثة

ENDODONTICS INSTRUMENTS

ANTERIOR

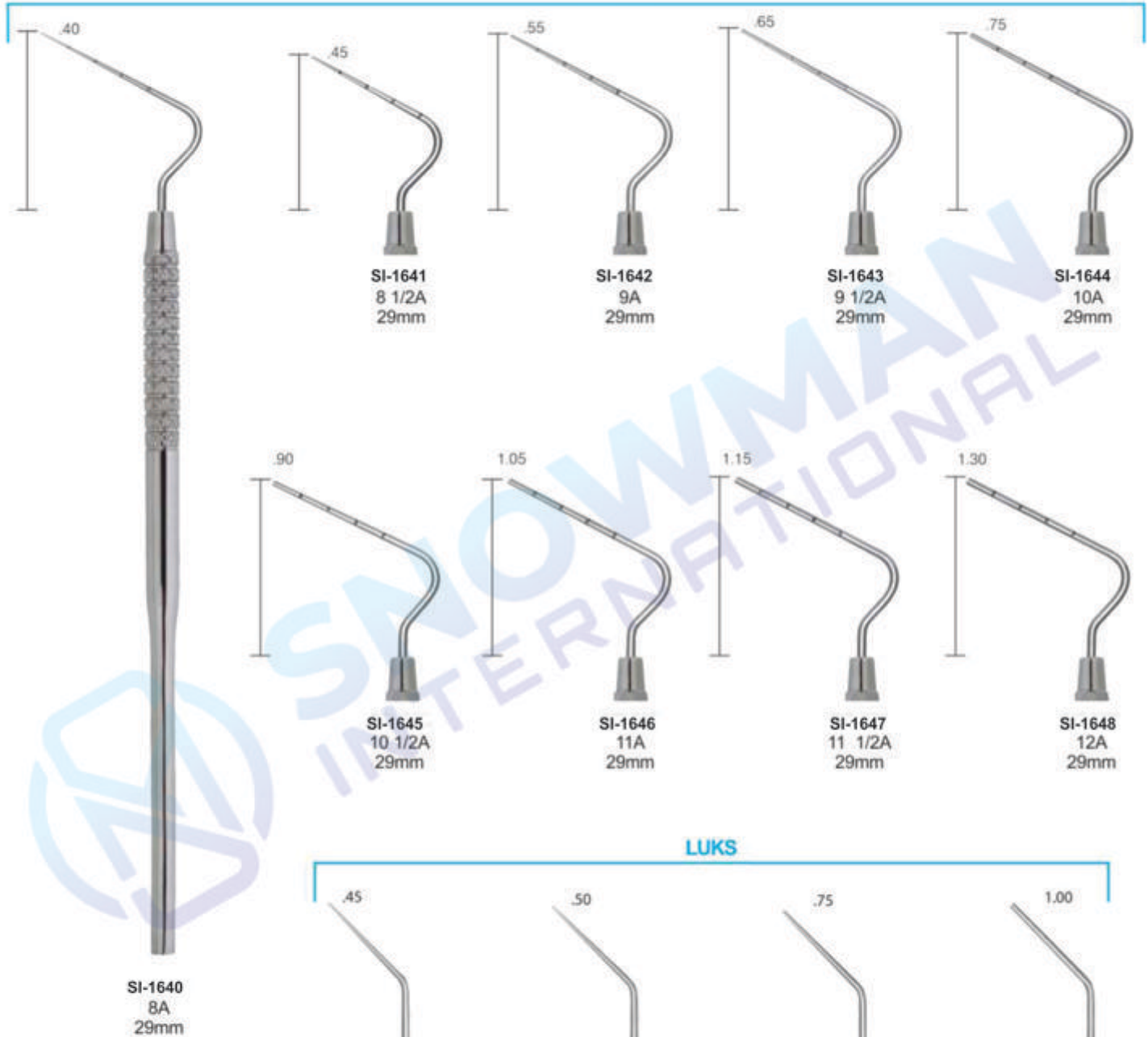

LUKS

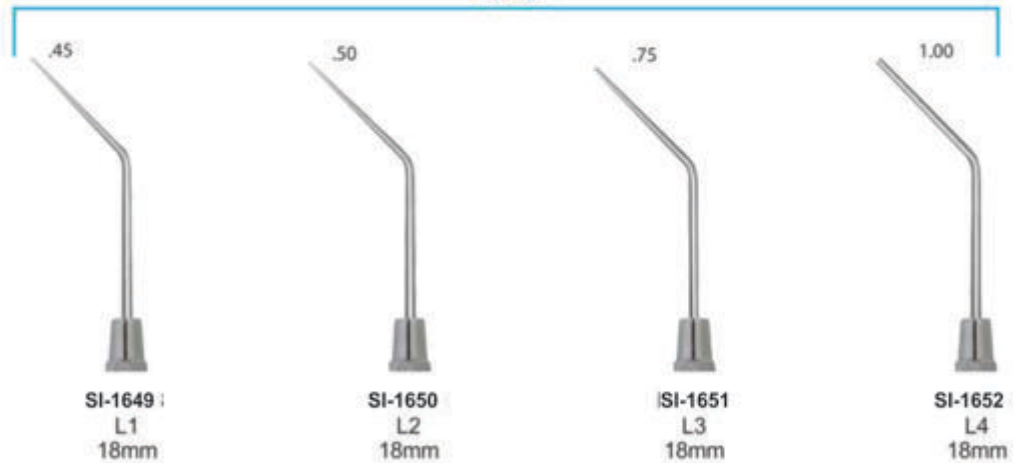

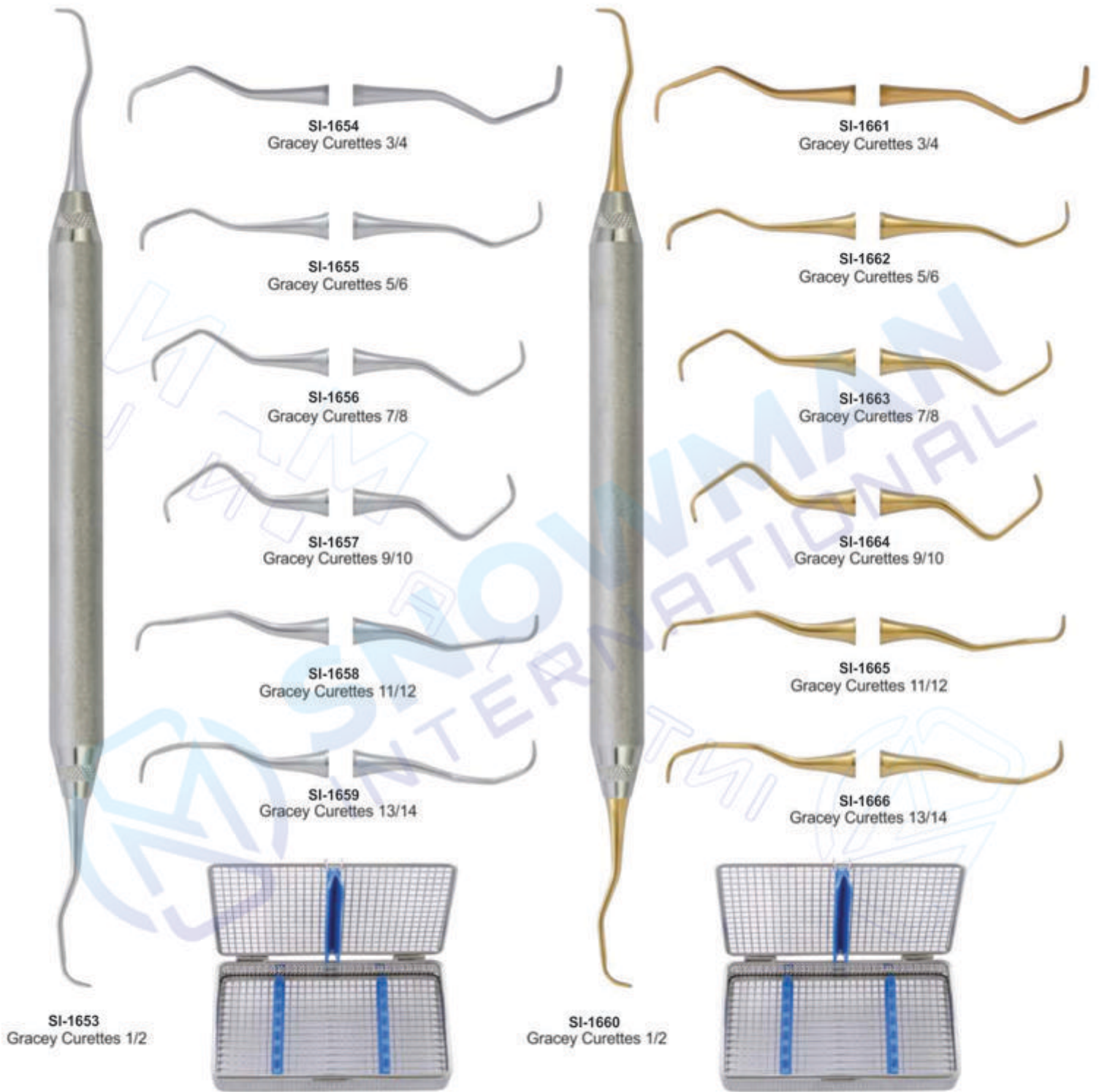

GRACEY MINI FIVE

Hollow Handle 9.5mm, Length 170mm Ceramic Coated Handle



SI-1668
Fig. 3/4 Gracey 3M



SI-1669
Fig. 5/6 Gracey 3M



SI-1670
Fig. 7/8 Gracey 3M
Buccal and lingual/
Palatal surfaces



SI-1671
Fig. 11/12 Gracey 3M
Mesial



SI-1672
Fig. 13/14 Gracey 3M
Distal



SI-1667
Fig. 1/2
Gracey 3m

GRACEY AFTER FIVE

Hollow Handle 9.5mm, Length 170mm Ceramic Coated Handle



SI-1674
Gracey 3/4 AF



SI-1675
Gracey 5/6 AF



SI-1676
Gracey 7/8 AF



SI-1677
Gracey 11/12 AF



SI-1678
Gracey 13/14 AF



SI-1673
Gracey
1/2 AF



Gracey Curettes



SI-1679 Fig. 1/2 GR - Gracey
Buccal surfaces

3...1	1...3
3...1	1...3



SI-1680 Fig. 3/4 GR - Gracey
Lingual/Palatal surfaces

5...1	1...5
5...1	1...5



SI-1681 Fig. 5/6 GR - Gracey

5...1	1...5
5...1	1...5



SI-1682 Fig. 7/8 GR - Gracey
Buccal and lingual/
palatal surfaces

8...4	4...8
8...4	4...8



SI-1683 Fig. 9/10 GR - Gracey
Buccal and lingual/
palatal surfaces more angled

8...4	4...8
8...4	4...8



SI-1684 Fig. 11/12 GR - Gracey
Mesial

8...4	4...8
8...4	4...8



SI-1685 Fig. 13/14 GR - Gracey
Distal

8...4	4...8
8...4	4...8



SI-1686 Fig. 15/16 GR - Gracey
Mesial

8...4	4...8
8...4	4...8



SI-1687 Fig. 17/18 GR - Gracey
Distal

8...4	4...8
8...4	4...8

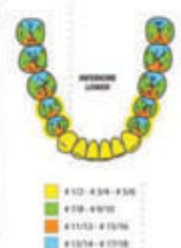

Sickle Scalers



SI-1688 Fig. U15/33 - Towner-Jaquette



SI-1689 Fig. U15/30 - Towner-Jaquette



SI-1690 Fig. H5/33



SI-1691 Fig. H6/H7



SI-1692 Fig. 30/33 - Jaquette



SI-1693 Fig. T2/T3 - Taylor



SI-1694 Fig. 204



SI-1695 Fig. 204S



SI-1696 Fig. 11/12 - MC - McCall
Mesial



SI-1697 Fig. 13/14 - MC - McCall
Distal



Straight and curved sickle scalers
Feature: 2 cutting edges curved facial component tipped ends



Universal curettes
are characterized by an angle of 90° between the terminal stem and the cutting component.

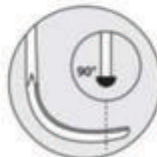

Gracey curettes
are characterized by an angle of 70° between the terminal stem and the cutting component.

Universal Curettes



SI-1698 Fig. 13S/14S - MC - McCall



SI-1699 Fig. 17S/18S - MC - McCall Distal



SI-1700 Fig. M23



SI-1701 Fig. 204SD



SI-1702 Fig. YG7/8-Younger Good



SI-1703 Fig. L 1/2 - Langer



SI-1704 Fig. L 3/4 - Langer



SI-1705 Fig. L 5/6 - Langer



SI-1706 Fig. M 23A



SI-1707 Fig. M 23B



Straight and curved sickle scalers
Feature: 2 cutting edges curved facial component tipped ends



Universal curettes
are characterized by an angle of 90° between the terminal stem and the cutting component.

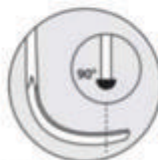

Gracey curettes
are characterized by an angle of 70° between the terminal stem and the cutting component.



Periodontal knives





Chisels
Diamond coated margin trimmers



Thanks to the diamond-coated hand instruments the margins are evenly levelled.

Margin trimmers



SI-1726
1TH2 Hirt



SI-1727
5TH6 Hirt



SI-1728
3TH4 Hirt



SI-1729
7TH8 Hirt



SI-1730
62NS61

2.0 MM

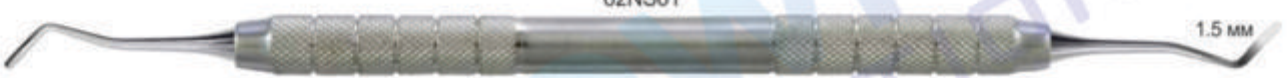

SI-1731
37NS36

1.5 MM



SI-1732
66NS65

1.0 MM

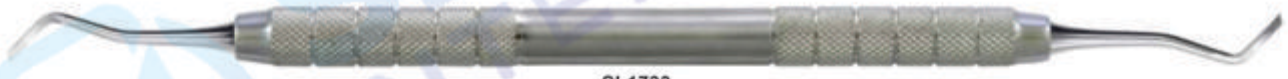

SI-1733
79CI80 Black



SI-1734
77CI78 Black



SI-1735
279CI280 Black



SI-1736
277CI278 Black

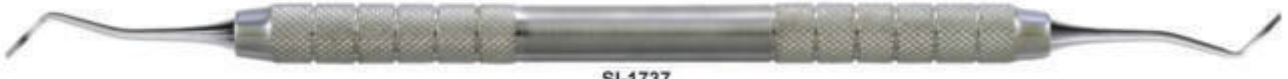

SI-1737
179CI180 Black



SI-1738
177CI178 Black

CHISELS



SI-1739
1/2 Werdelstaedt



SI-1740
3/4 Werdelstaedt



SI-1741
7 Straight



SI-1742
5/6 Straight



SI-1743
7/10 Straight



SI-1744
8/9 Binangle



SI-1745
11/12 Binangle



SI-1746
40/41 Binangle

Tartar Remover Instruments Solid Handle Ø 6 mm



SI-1747
Fig. 1



SI-1748
Fig. 1L
Left



SI-1749
Fig. 1R
Right



SI-1750
Fig. 2L
left



SI-1751
Fig. 2R
Right



SI-1752



SI-1753



SI-1754



SI-1755
WHITE 28



SI-1756
WHITE 29



SI-1757
WHITE 31



SI-1758
WHITE 32



SI-1759
WHITE 33



SI-1760
WHITE 34



SI-1761
WESTCOTT 21



SI-1762
WESTCOTT 21B



SI-1763



SI-1764



SI-1765
WHITE



SI-1766
WHITE



SI-1767



SI-1768



SI-1769



SI-1770

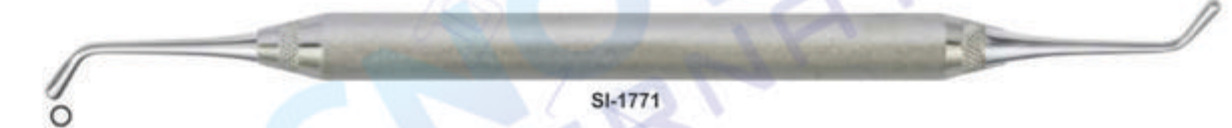

SI-1771



SI-1772



SI-1773



SI-1774



SI-1775



SI-1776
PLANATOR



SI-1777
PLANATOR



SI-1778



SI-1779



SI-1780



SI-1781



SI-1782



SI-1783



SI-1784



SI-1785



Ball Burnishers



SI-1786



SI-1787



SI-1788



SI-1789



Hatches

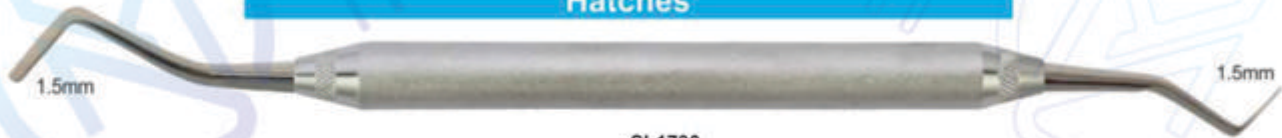

SI-1790



SI-1791



SI-1792
Mini-Spatel



SI-1793
Mini-Spatel

Spatulas rounded and sharp

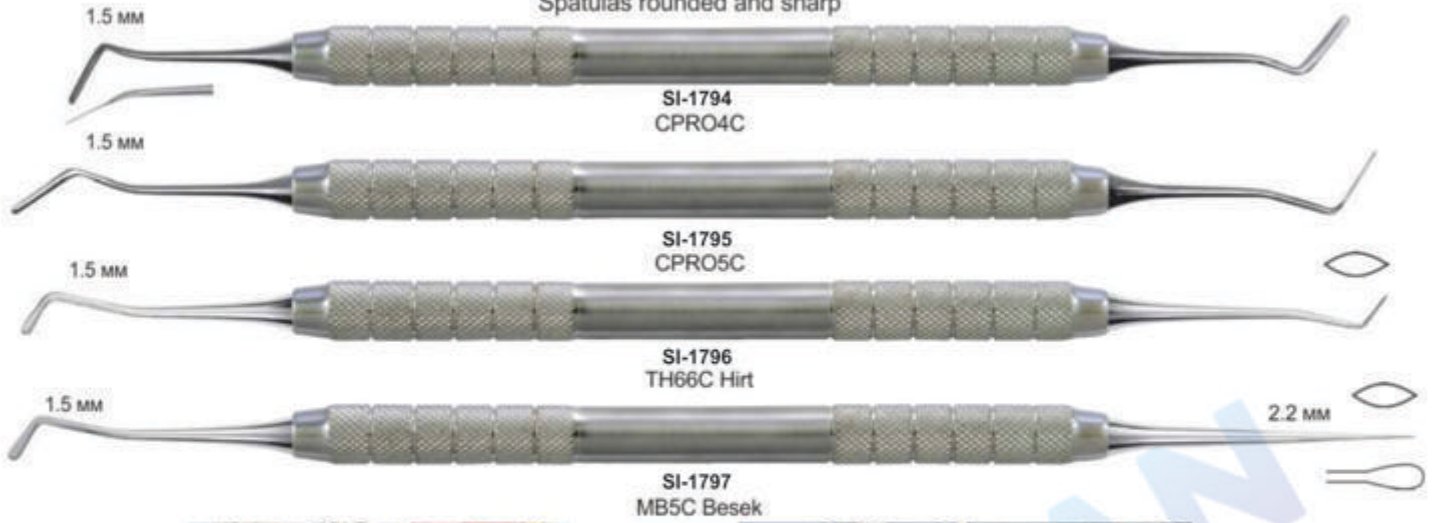

Spatulas Blade Thickness 0.22 mm



Spatulas

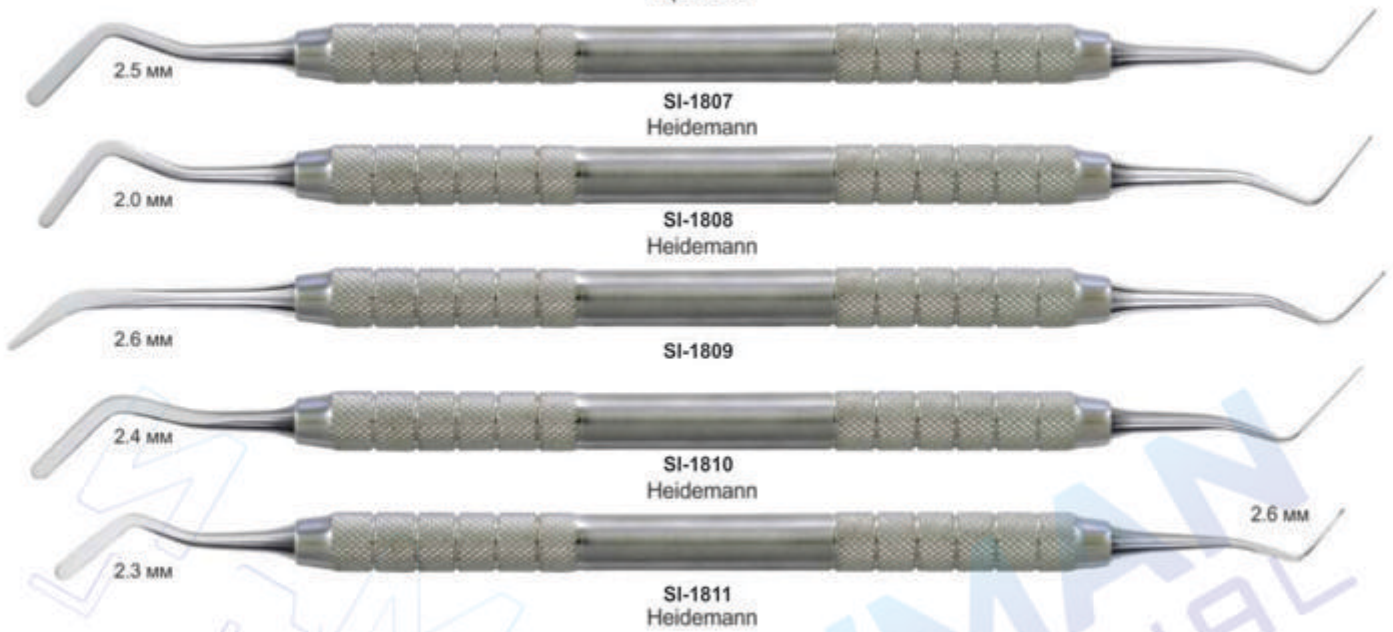

Spatulas-Pluggers



Water drop Our excavators have particularly sharp blades, free of burrs and perfectly rounded.







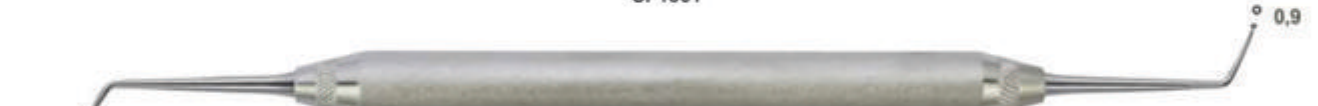
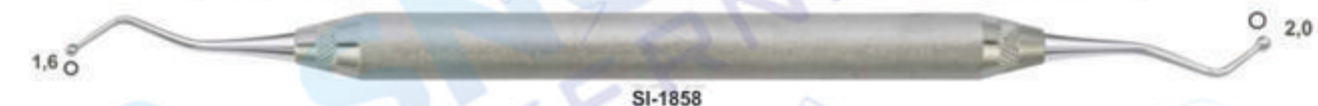



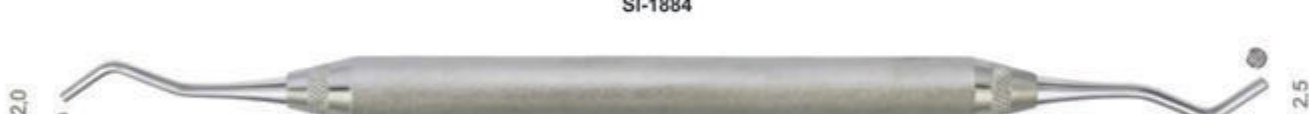
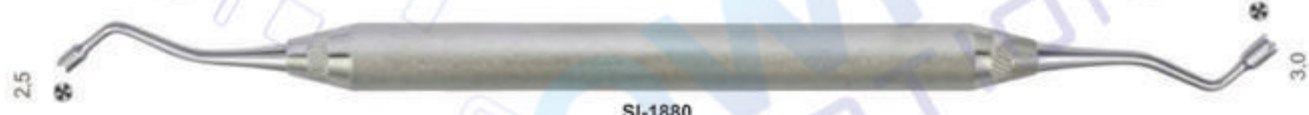





SI-1896
WILLIAMS



SI-1897
WILLIAMS



SI-1898
WILLIAMS



SI-1899



SI-1900



SI-1901



SI-1902



SI-1903



SI-1904



SI-1905





Serrated Pluggers



Ø 0.9 MM		SI-1925 OP36M	Ø 1.2 MM
Ø 1.1 MM		SI-1926 OP36D	Ø 1.6 MM
Ø 1.6 MM		SI-1927 Op36	Ø 2.2 MM
Ø 1.0 MM		SI-1928 Op52	Ø 1.7 MM
Ø 2.2 MM		SI-1929 Zi51	Ø 2.6 MM
Ø 1.8 MM		SI-1930 Op44	Ø 2.2 MM
Ø 1.7 MM		SI-1931 1BR2	Ø 2.6 MM
Ø 2.6 MM		SI-1932 2BR3	Ø 3.6 MM





SI-1933 MF2C
Fuzzi



SI-1934
Pj4

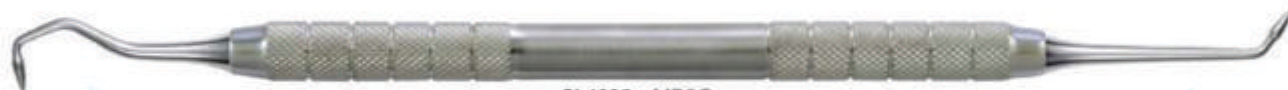

SI-1935 MB3C
Besek



SI-1936
HZ3C



SI-1937
CPRO3C



SI-1938 Mo1
Monari



SI-1939 TH28C
Hirt



SI-1940
HZ25C



SI-1941
Ck10



SI-1942
CK28BC



SI-1943 Op37
Carver



SI-1944
28BR29

Round excavators

Cariology

- for the removal of softened, carious dentin
- for the removal of temporary fillings

Surgery

- to sever the periodontal ligament prior to extraction
- for the removal of granulation tissue after extraction

Design: Round working end Curved cutting edge



Round Excavator, 1.0 mm
SI-1945



Round Excavator, 1.5 mm
SI-1946



Round Excavator, 2.0 mm
SI-1947

Triple-angled back action excavators



Triple-angled Back Action Excavator, 1.0 mm
SI-1948



Triple-angled Back Action Excavator, 1.5 mm
SI-1949



Triple-angled Back Action Excavator, 2.0 mm
SI-1950



Triple-angled Back Action Excavator, 3.5 mm
SI-1951



FILLING INSTRUMENTS

- Инструменты для реставрации
- Instruments pour plombage
- Füllungsinstrumente (mit Kontrawinkel)
- Инструменти для реставрації
- Instrumentos para obturaciones
- ملء الصكوك

COMPOSITE/PLASTIC FILLING INSTRUMENTS SOLID HANDLE 6MM, LENGTH 170MM

BLACK

PLUGGERS/CONDENSERS

Hollenback

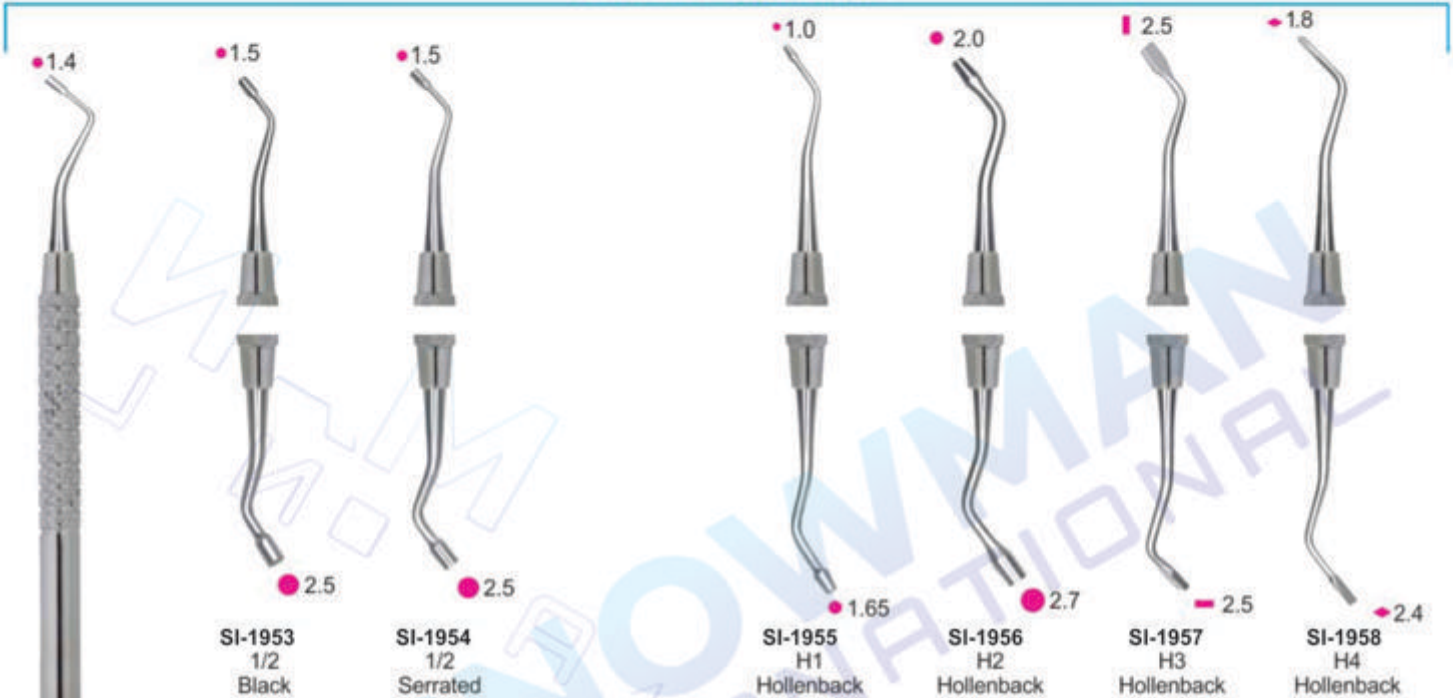

MARQUETTE CONDENSER

MORTONSON

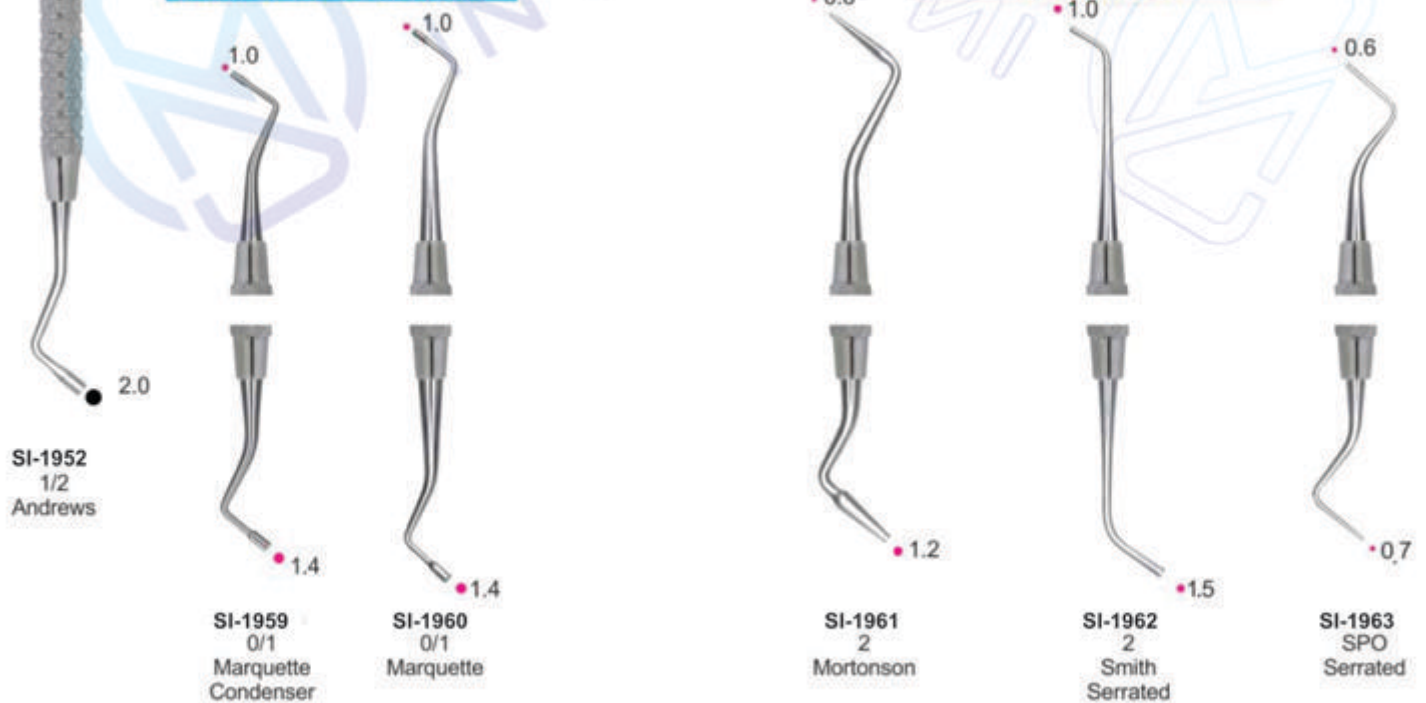

FILLING INSTRUMENTS

- Инструменты для реставрации
- Instruments pour plombage
- Füllungsinstrumente (mit Kontrawinkel)
- Инструменти для реставрації
- Instrumentos para obturaciones
- ملء الصكوك

RESTORATIVE INSTRUMENTS SOLID HANDLE 6MM, LENGTH 170MM Back Action Filling Instruments

Tanner Filling Instruments

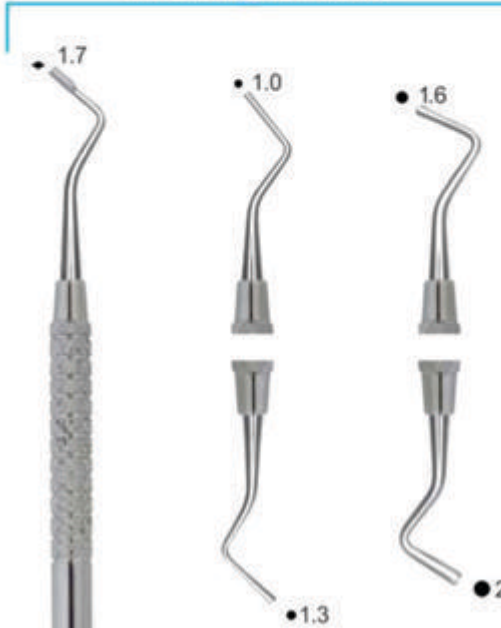

SI-1965
2T
Tanner

SI-1966
3T
Tanner

SI-1967
9/10
Back Action

SI-1968
11/12
Back Action

SI-1969
153
English Pattern
Serrated

SI-1970
153
English Pattern
Serrated

BURNISHERS

BALL

BEAVERTAIL

ACORN

LADMORE

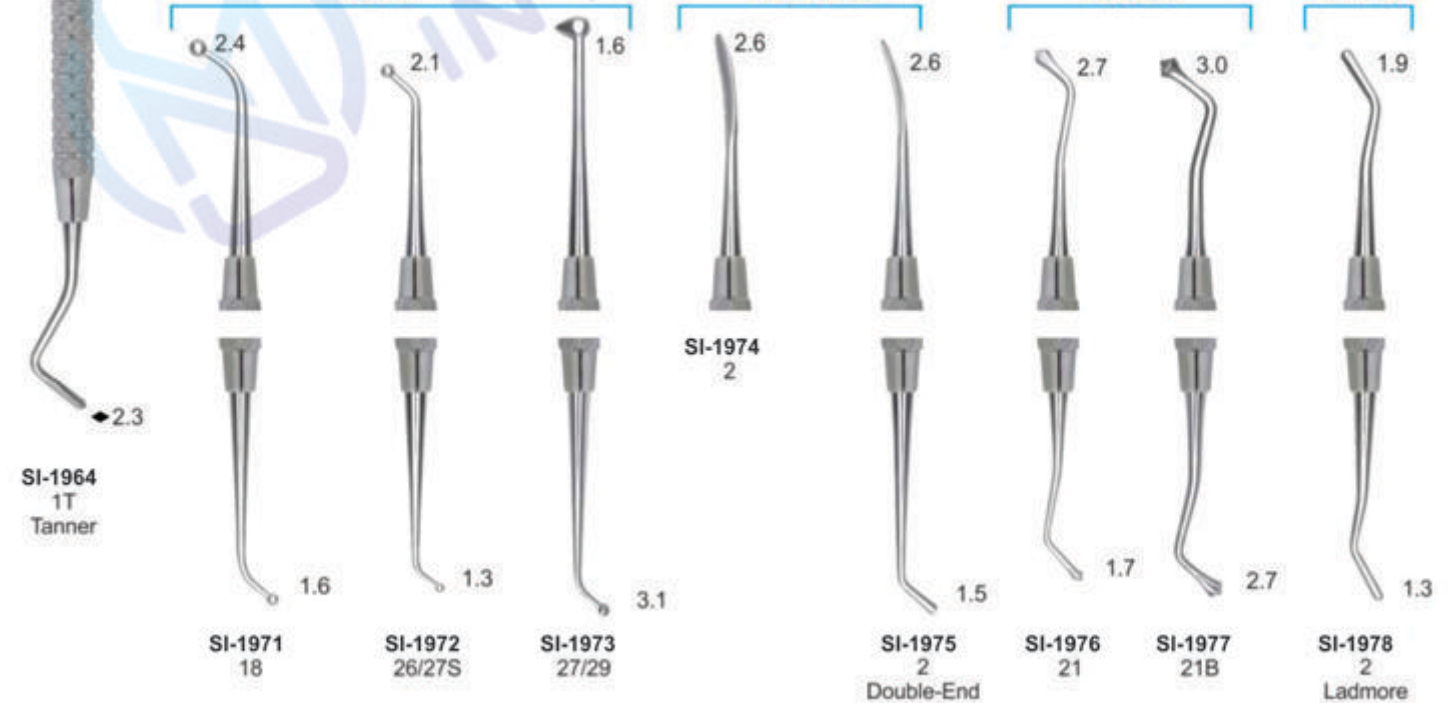

SI-1964
1T
Tanner

SI-1971
18

SI-1972
26/27S

SI-1973
27/29

SI-1974
2

SI-1975
2
Double-End

SI-1976
21

SI-1977
21B

SI-1978
2
Ladmore

CARVERS INSTRUMENTS

- Инструменты для реставрации
- Instruments a modeler
- Modellierinstrumente

- Инструменти для реставрації
- Instrumentos para modelar
- أدوات تقطيع

P.K. THOMS WAXING INSTRUMENTS SOLID HANDLE 6mm

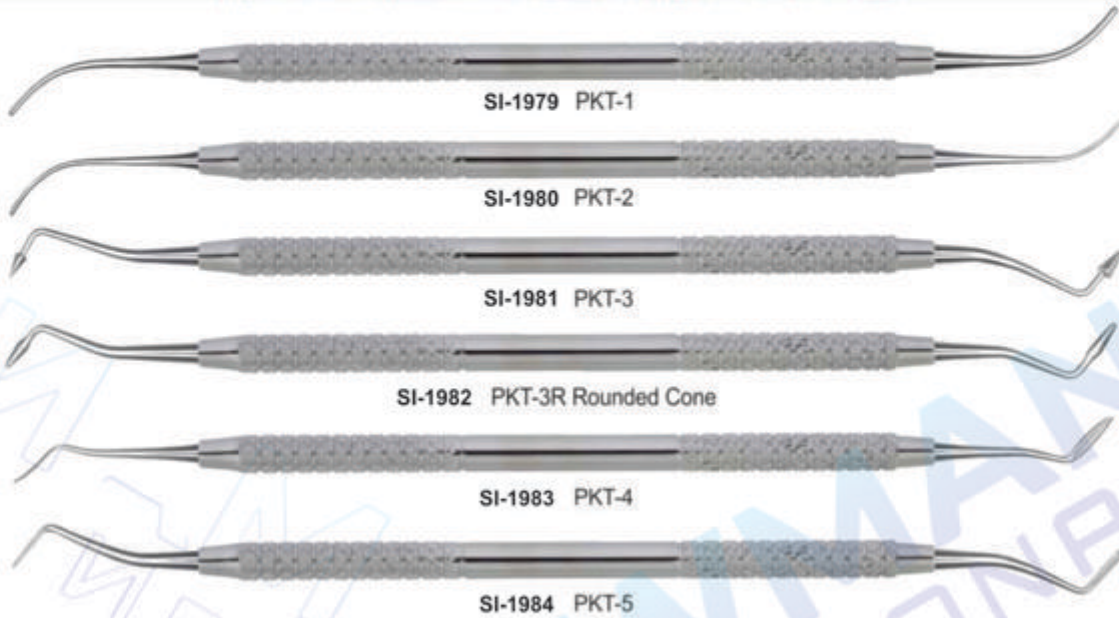

SI-1985
Composite Instruments Blue
Titanium with Cassettes



SI-1986
P.k. Thomas Waxing Instruments Kit

COMPOSITE INSTRUMENTS TITANIUM BLUE ENDODONTIC

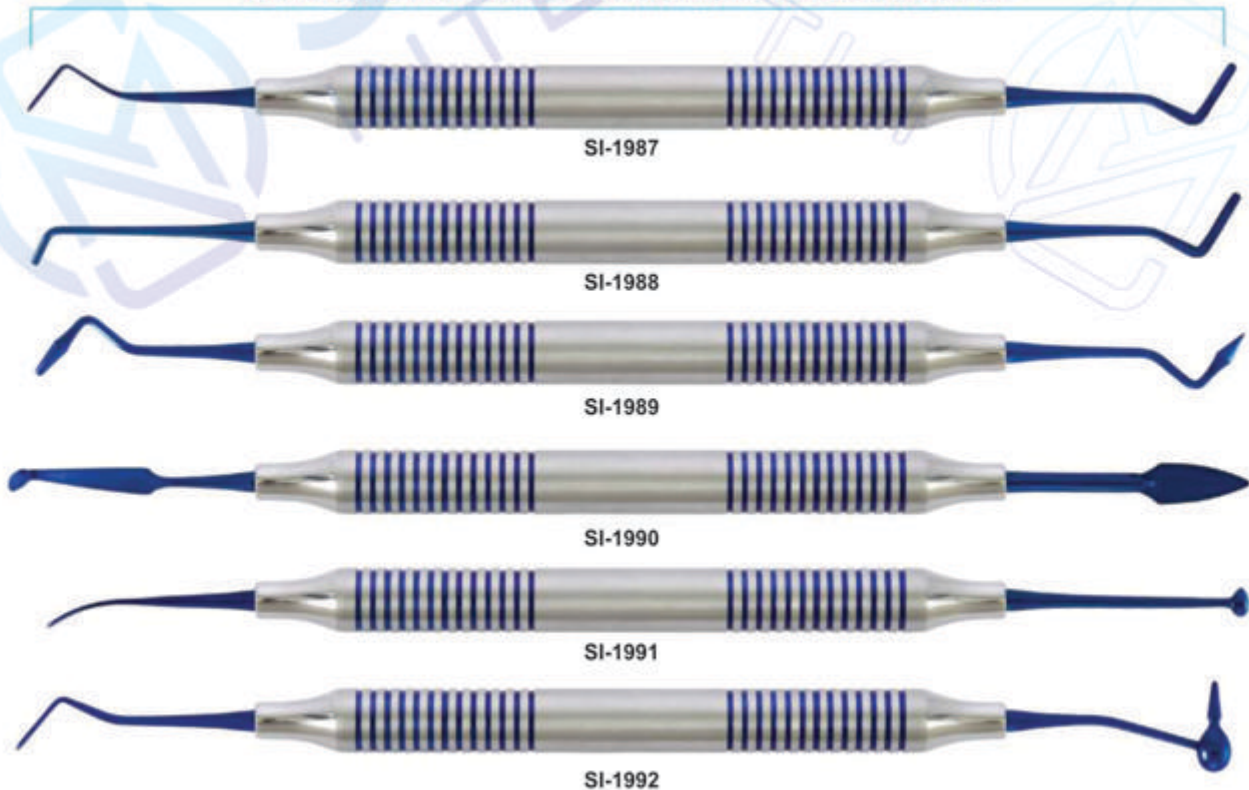

CARVERS INSTRUMENTS

- Инструменты для реставрации
- Instruments a modeler
- Modellierinstrumente
- Инструменти для реставрації
- Instrumentos para modelar
- أدوات تقطع



SI-1993



SI-1994



SI-1995



SI-1996



SI-1997

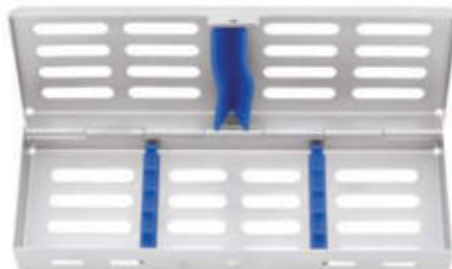

Cassette For 5 Instruments
SI-1998

FILLING INSTRUMENTS

- Инструменты для реставрации
- Instruments pour plombage
- Füllungsinstrumente (mit Kontrawinkel)
- Инструменти для реставрації
- Instrumentos para obturaciones
- ملء الصكوك

FILLING INSTRUMENTS (Gold Pointed) SOLID HANDLE 6MM, LENGTH 170MM



SI-1999 1.5mm / 1.5mm

SI-2000 2.0mm / 2.0mm

SI-2001 2.0mm / 2.0mm

SI-2002 2.5mm / 2.5mm

SI-2003 1.3mm / 0.9mm

SI-2004 1.6mm / 1.3mm

SI-2005 2.4mm / 1.8mm

SI-2006 2.4mm / 2.0mm

SI-2007 1.3mm / 1.5mm

SI-2008 1.8mm / 1.2mm

Filling instrument,
spatula 6 mm solid handle,
length 170 mm,

Filling instrument
6 mm
length 175 mm,

Filling instrument,
ball 6 mm
length 170 mm,

Filling instrument,
ball / spatula
6 mm
length 175 mm,

Filling instrument,
plan / plan 6 mm
length 165 mm,

COMPOSITE FILLING INSTRUMENTS

- Инструменты для реставрации
- Instruments pour plombage
- Füllungsinstrumente (mit Kontrawinkel)
- Инструменти для реставрації
- Instrumentos para obturaciones
- ملء الصكوك

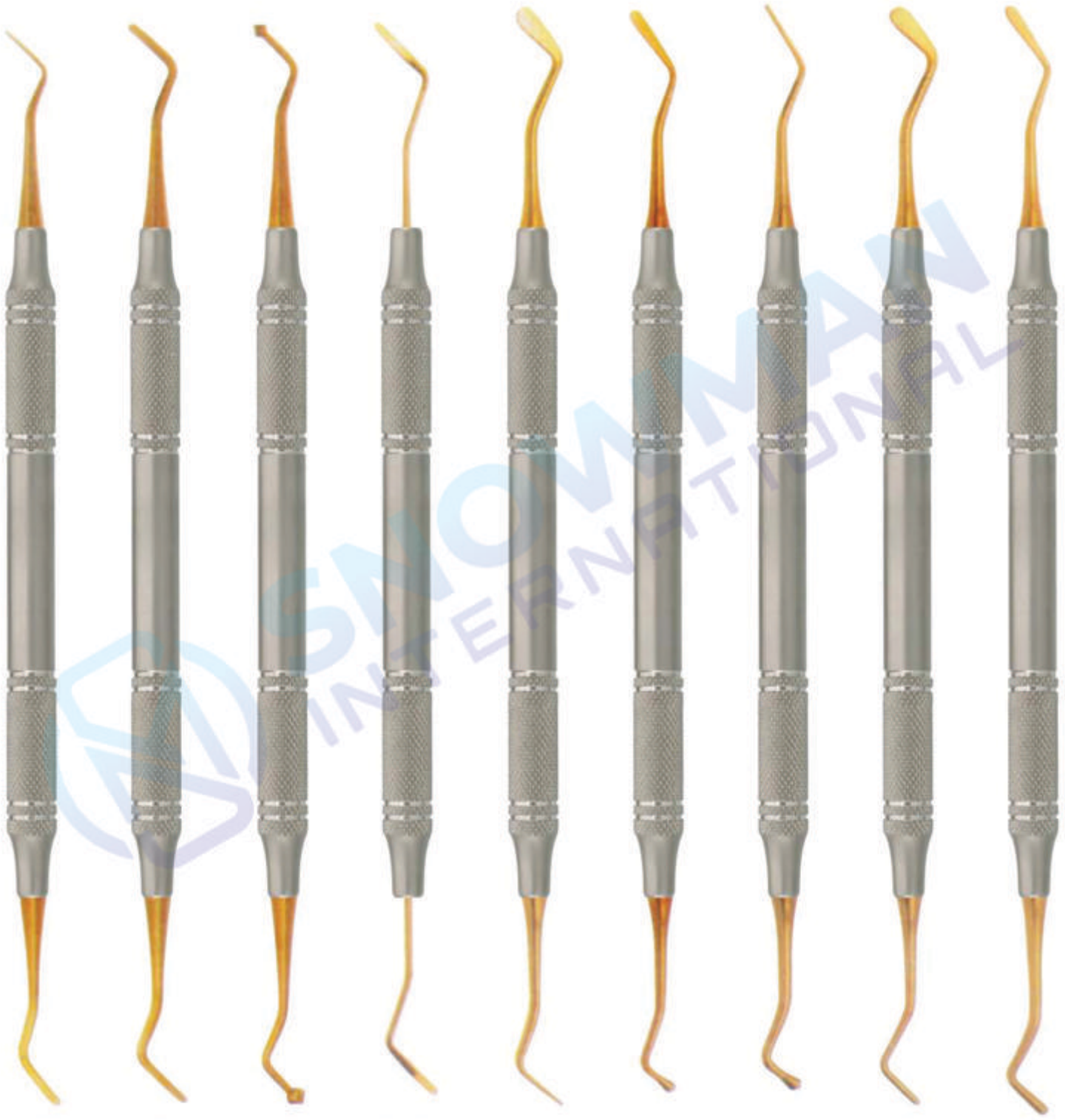

SI-2009

SI-2010

SI-2011

SI-2012

SI-2013

SI-2014

SI-2015

SI-2016

SI-2017

COMPOSITE FILLING INSTRUMENTS

- Инструменты для реставрации
- Instruments pour plombage
- Füllungsinstrumente (mit Kontrawinkel)
- Инструменти для реставрації
- Instrumentos para obturaciones
- ملء الصكوك

Composite Gold Tip Instruments



MISCELLANEOUS PRODUCTS

- Прочие товары
- Divers produits et services
- Sonstige Produkte
- Інші товари
- Varios Productos
- المنتجات المتنوعة



SI-2029
X Ray Film Hangers



SI-2030
X Ray Film Hangers



SI-2031
X Ray Film Hangers



SI-2032
X Ray Film Hangers



SI-2033
X Ray Film Hangers



SI-2034
X Ray Film Hangers



SI-2035
X Ray Film Hangers



SI-2036



SI-2037



SI-2038



Dissecting Set
SI-2039 Set of 9 Pcs.
SI-2040 Set of 11 Pcs.



SI-2041
Napkin holder with metal chain

SI-2042
Napkin Holder with Plastic Chain



Mouth Props
SI-2043
Small

Mouth Props
SI-2044
Medium

Mouth Props
SI-2045
Large

Key Rings



SI-2046



SI-2047



SI-2048



SI-2049



SI-2050



SI-2051

CEMENT SPATULAS

- Шпатели для цемента
 - Spatules à ciment
 - Zementspatel
- Шпатели для цементу
 - Espátulas para cemento
 - ملاعق الأسمنت



WAX KNIVES

- Ножи для воска
- Couteaux a cire
- Wachsmesser

- Ножи для воску
- Cuchillos para cera
- السكاكين الشمع

ALGINATE, PLASTER SPATULAS, WAX KNIVES PLASTER FOR KNIVES & PLASTER SHEAR



SI-2074
Wooden Handle
Fig. 5
21.5 cm



SI-2075
Wooden Handle
Fig. 7
19.5 cm curved



SI-2076
Wooden Handle
Fig. 8
20 cm curved



SI-2077
Wooden Handle
Fig. 9
22.5 cm curved



SI-2078
Hook Knives



SI-209
Fig. 1
Lessmann
12.5 cm



SI-2080
Fig. 2
Lessmann
17 cm



SI-2081
Fig. 1
with small spoon
12.5 cm



SI-2082
Fig. 2
with large spoon
17 cm



SI-2083
Bacolite Handle
Wax Knives,
Small



SI-2084
Bacolite Handle
Wax Knives,
Large



SI-2085
Wooden Handle
Wax Knives,
Small



SI-2086
Wooden Handle
Wax Knives,
Large



SI-2087
Plaster Knife



SI-2088
Fig. 1
17 cm



SI-2089
Fig. 3
16 cm



SI-2090
Fig. 4
16 cm



SI-2091
Special Inox
19.5 cm

ARTICULATORS

- Артикуляторы
 - Artocilar
 - Artikulations
- Артикулятори
 - Articuler
 - ارتیکولاتورس



SI-2092

Technical Datas:

Intercondylar distance
condylar inclination
Bennet angle
Incisal table inclination
Distance between mounting plates
Weight
Opening (item 5000)
Opening (item 5010)

120 mm.
fixed at 30°
fixed at 7°
10°
85 mm.
400 gr.
125°
180°



SI-2093

Technical Datas:

Intercondylar distance
condylar inclination
Bennet angle
Incisal table inclination
Distance between mounting plates
Weight
Opening

110 mm.
fixed at 30°
fixed at 7°
flat
85 mm.
450 gr.
180°



SI-2094

Stainless Steel Finishing

SI-2095
Royal Blue



SI-2096



SI-2097



SI-2098



SI-2099



SI-2100



SI-2101



SI-2102



SI-2103



SI-2104



SI-2105
Nakawalni
Dental Laboratory
Instrument

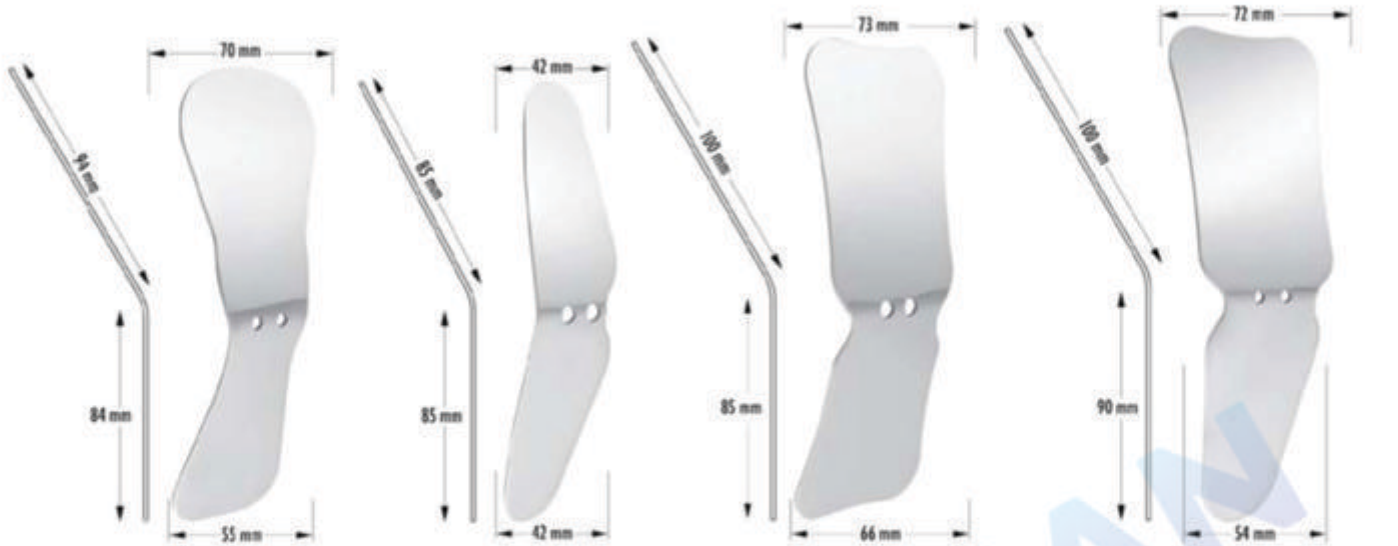

SI-2106 Adult Palatal /
SI-2107 Child Palatal

SI-2108
Buccal

SI-2109 Adult Palatal /
SI-2110 Child Palatal

SI-2111 Adult Palatal /
SI-2112 Adult Buccal



SI-2113 Lingual upper /
SI-2114 Lingual Lower

SI-2115 Adult Buccal /
SI-2116 Child Buccal

SI-2117 Child Palatal /
SI-2118 Child Buccal

DE-1228
Palatal-Adult

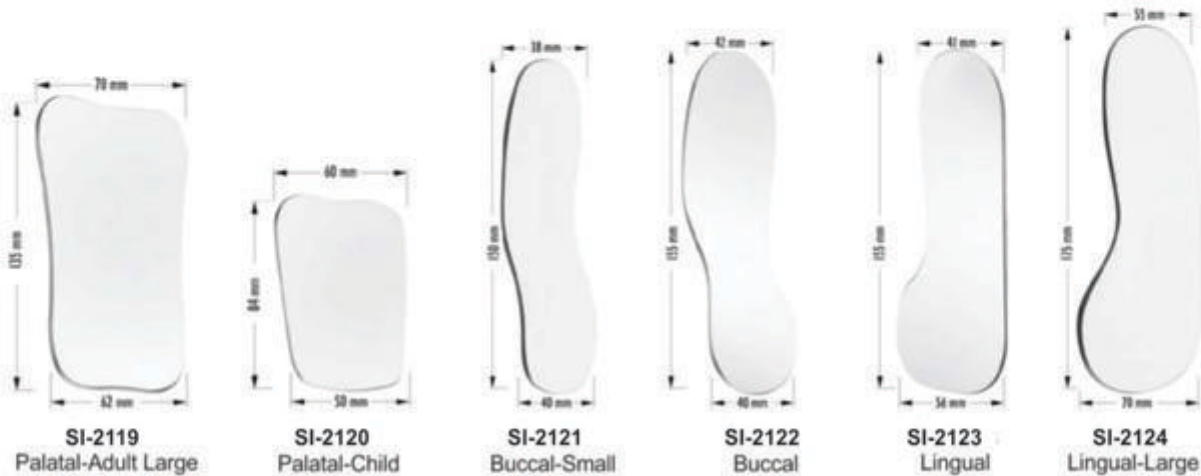

SI-2119
Palatal-Adult Large

SI-2120
Palatal-Child

SI-2121
Buccal-Small

SI-2122
Buccal

SI-2123
Lingual

SI-2124
Lingual-Large

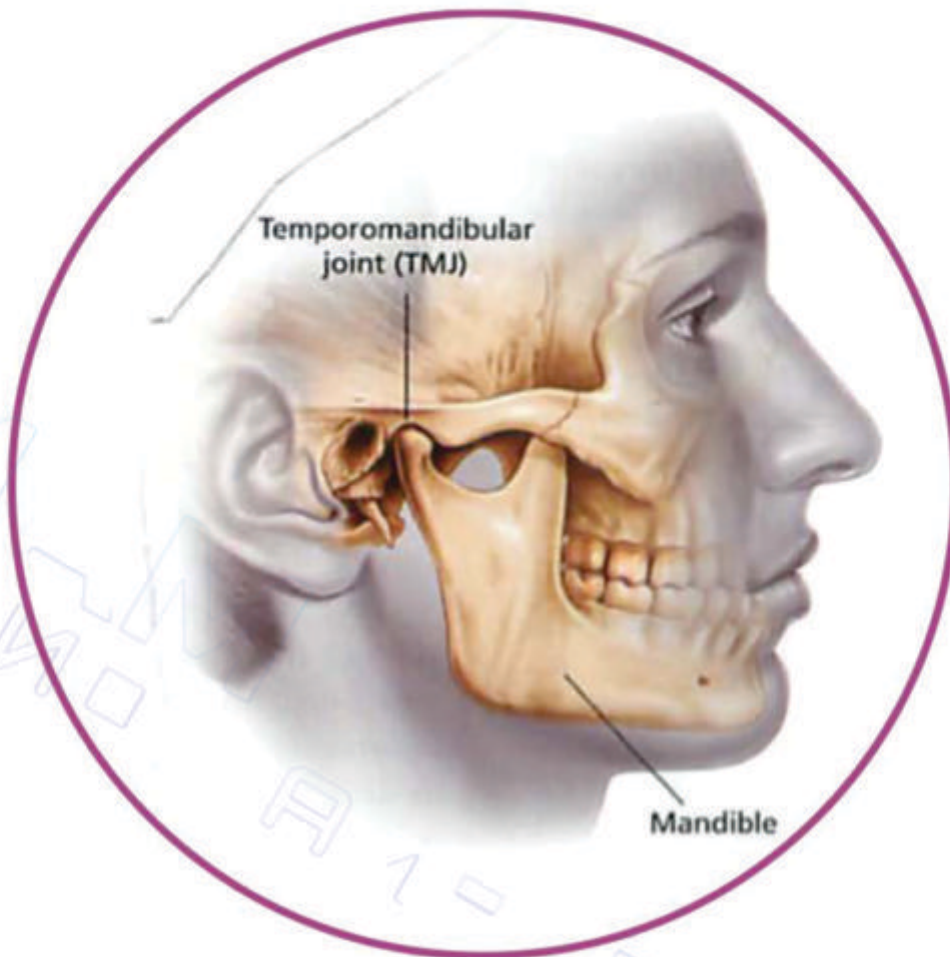

RETRACTORS - MOUTH GAGS

- Роторасширители
- Ecarteurs - Ouvre-bouches
- Vestibulumabhalter / Mundspanner
- Роторозширювачі
- Separadores - Abre-bocas
- الكاشطات والكشطات الفم



SI-2125
HMG
Heister
130mm



SI-2126
Mouth Gag Molt
11 cm for (Children)



SI-2127
Mouth Gag Molt
14 cm for (Adults)



Sternberg Retractors
SI-2128 140 mm
SI-2129 180 mm



Columbia Retractor
SI-2130 140 mm



SI-2131
Wangen Holder
vestibule
15 cm, with or without
lip protection.



SI-2132
Wangen Holder
vestibule 15 cm, with
or without lip protection



SI-2133
Wangen Holder
with dual
function, 17 cm



SI-2134
140 mm

SI-2135
150 mm

Weider Retractor

RETRACTORS - MOUTH GAGS

- Роторасширители
- Роторозширювачі
- Ecarteurs - Ouvre-bouches
- Separadores - Abre-bocas
- Vestibulumabhalter / Mundspanner
- الكاشطات-الكمامات الفم



Weitlaner
Fig. 1
SI-2136 10.5cm
SI-2137 13.5cm



Weitlaner
Fig. 2
SI-2138 10.5cm
SI-2139 13.5cm



SI-2140
Lip & Cheek Retractor
Stainless Steel
Double Ended



SI-2141
Simplex Retractor
Stainless Steel
Single Ended



Weitlander
SI-2142 11cm
SI-2143 13cm
SI-2144 15cm



SI-2148
Denhard
12 cm



SI-2149
Roser-König
16 cm



SI-2150
Roser-König
19 cm



Jennings
SI-2145 11cm
SI-2146 13cm
SI-2147 15cm

RETRACTORS

- Ранорасширители
 - Ecarteurs
 - Wundhaken
- Ранорозширювачі
 - Separadores
 - الكاشحات

Wound, Bendable
Retractor, individually or as saving kit!



SI-2151
Cheek Retainer
One-sided
Long



SI-2152
Cheek Retainer
One-sided
Long



SI-2153
Cheek Retainer
One-sided
Long



**Ergo Grip
Retractor**
SI-2154 24 cm
ergonomic handle,



Ivory Retractors
Width adjustable
& fixable,
SI-2155 20 cm



Bruenings Retractors
tongue depressors
SI-2156 19 cm



**Minnesota
Retractors**
SI-2157 16 cm



Ribbon Retractors
SI-2158 20 cm
easy to bend
by hand,



Bishop Retractors
retractor and tongue
pushers Bishop with
comfortable margin
SI-2159 16 cm



**Combination
Retractors**
SI-2160 25 cm

RETRACTORS

- Ранорасширители
- Ecarteurs
- Wundhaken
- Ранорозширювачі
- Separadores
- كاشحات



SI-2161
Unique Retractors
Length 175 mm
angled 45°



SI-2162
Unique Retractors
Length 175 mm
angled 90°



SI-2163
Retractors
16cm



SI-2164
Retractors
19cm



SI-2165
Mini-Langenbeck
Retractors
16 cm, hooks 22 mm



SI-2166
US army Retractors
21 cm, 2



SI-2167
ALM Retractor
about 8 cm



SI-2168
Senn Mueller Retractor
17 cm, hooks 22 mm

RETRACTORS

- Ранорасширители
 - Ecarteurs
 - Wundhaken
- Ранорозширювачі
 - Separadores
 - الكاشطات



SI-2169
Langenbeck Retractors
surgical-flat
21 cm, hook
30x16 mm



SI-2170
Langenbeck Retractors
surgical-flat
21 cm, hook
42x11 mm



SI-2171
Langenbeck Retractors
surgical-flat
21 cm, hook
63x12 mm



Langenbeck Retractors
surgical-flat
21 cm, hook
SI-2172 30x16 mm
SI-2173 42x11 mm
SI-2174 63x12 mm



Langenbeck Retractors
21 cm, hook
SI-2175 30x11 mm
SI-2176 30x16 mm



SI-2177
Middelborpf
Retractors
21 cm



SI-2178
Farabeuf
(120 X 12mm
Set of 2 pices)



SI-2179
Retractor Seldin



SI-2180
Feldman Retractor
14cm

GUM SCISSORS

- Ножницы десневые
 - Ciseaux a gencives
 - Zahnfleischscheren
- Ножницы для ясен
 - Tijeras para encias
 - مقص صمغ



SI-2181
Iris
115mm
Straight



SI-2182
Iris
115mm
Curved



SI-2183
Goldman-Fox
130mm
Saw edge, straight



SI-2184
Goldman-Fox
130mm
Saw edge, Curved



SI-2185
La Grange
115mm
Saw edge, double Curved



Mayo
SI-2186 140mm
SI-2187 170mm
SI-2188 230mm
Straight



Mayo
SI-2189 140mm
SI-2190 170mm
SI-2191 230mm
Curved



Metzenbaum
SI-2192 145mm
SI-2193 180mm
SI-2194 200mm
Straight



Metzenbaum
SI-2195 145mm
SI-2196 180mm
SI-2197 200mm
Curved



SI-2198
Kelly
160mm
Straight



SI-2199
Kelly
160mm
Curved



SI-2200
Iris
115mm
Straight



SI-2201
Iris
115mm
Curved



SI-2202
La Grange
115mm
Double Curved



SI-2203
Goldman-Fox
130mm, Straight



SI-2204
Goldman-Fox
130mm, Curved



SI-2205
Kelly
160mm, Curved



SI-2206
Iris
115mm, Straight



SI-2207
Iris
115mm, Curved



SI-2208
Micro Iris
90mm, Curved

GUM SCISSORS

- Ножницы десневые
- Ciseaux a gencives
- Zahnfleischscheren
- Ножницы для ясен
- Tijeras para encias
- مقص صمغ



SI-2209
Iris
115mm
Angled



SI-2210
Iris
115mm
Curved



SI-2211
Goldman-Fox
130mm
Saw edge,
straight



SI-2212
Goldman-Fox
130mm
Saw edge,
curved



SI-2213
Goldman-Fox
130mm
Saw edge,
double curved



SI-2214
La Grange
115mm
Saw edge,
double curved



SI-2215
Neumann
120mm
Saw edge,
double curved



SI-2216
Kilner (Ragnell)
120mm
Straight



SI-2217
Kilner (Ragnell)
120mm
Curved



SI-2218
Joseph
140mm
Straight



SI-2219
Joseph
140mm
Curved



SI-2220
Kelly
160mm
Straight



SI-2221
Kelly
160mm
Curved



SI-2222
Locklin
160mm
Saw edge,
angular



SI-2223
Locklin
120mm
DE-1350
160mm
Saw edge, angular



SI-2224
Dean
170mm
Saw edge,
angular

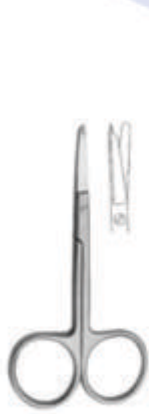

SI-2225
Spencer
90mm



SI-2226
Spencer
130mm



SI-2227
Spencer
115mm



SI-2228
Noyes
110mm, Straight



SI-2229
Noyes
110mm
Curved



SI-2230
Noyes
110mm
Angular



SI-2231
Castroviejo
150mm
Curved

GUM SCISSORS

NEEDLE HOLDERS

- Ножницы десневые
- Ciseaux a gencives
- Zahnfleischscheren

- Ножиці для ясен
- Tijeras para encias
- منصص صمغ

- Иглодержатели
- Porte-aiguilles
- Nadelhalter

- Голкотримачі
- Porta-agujas
- اصحاب ابرة



SI-2232
130mm
Straight



SI-2233
SI-2234
SI-2235

Mayo 130mm
Mayo 130mm
160mm 160mm
180mm 180mm
Straight Curved



SI-2236
SI-2237

Mayo 140mm
Mayo 140mm
200mm 200mm
Straight Curved



SI-2238
SI-2239

Metzenbaum
145mm 145mm
200mm 200mm
Straight Curved



SI-2240
Beebee
110mm
Saw edge,
straight



SI-2241
Beebee
110mm
Saw edge,
curved



SI-2242
Beebe
110mm
Saw edge, straight



SI-2243
Beebe
110mm
Saw edge, curved



SI-2244
Universal
120mm
Saw edge



SI-2245
Universal
120mm



Ryder
SI-2246 130mm
SI-2247 150mm
SI-2248 180mm



SI-2249
Halsey
130mm



SI-2250
Baumgartner
130mm



SI-2251
Derf
120mm



SI-2252
Delicate
150mm



Mayo-Hegar
SI-2253 130mm
SI-2254 160mm
SI-2255 180mm
SI-2256 200mm



SI-2257
Crile-Wood
150mm
straight



SI-2258
Crile-Wood
150mm
curved

NEEDLE HOLDERS

- Иглодержатели
- Porte-aiguilles
- Nadelhalter

- Голкотримачи
- Porta-agujas
- اصحاب ابرة



Ryder
SI-2259 130mm
SI-2260 150mm
SI-2261 180mm



SI-2262
Halsey
130mm



SI-2263
Baumgartner
130mm



SI-2264
Derf
120mm



SI-2265
Delicate
150mm



SI-2266
Adson
170mm



Mayo-Hegar
SI-2267 130mm
SI-2268 160mm
SI-2269 180mm
SI-2270 200mm



SI-2271
Crile-Wood
150mm



Castroviejo
SI-2272 str 140mm cvd
SI-2273 str 180mm cvd



Olsen-Hegar Needle Holder With Scissors
SI-2274 140mm



Gillies Needle Holder With Scissors
SI-2275 160mm



Mathieu
SI-2276 140mm
SI-2277 170mm



Castroviejo
SI-2278 str 140mm cvd
SI-2279 str 180mm cvd



Olsen-Hegar Needle Holder With Scissors
SI-2280 140mm



Gillies Needle Holder With Scissors
SI-2281 160mm

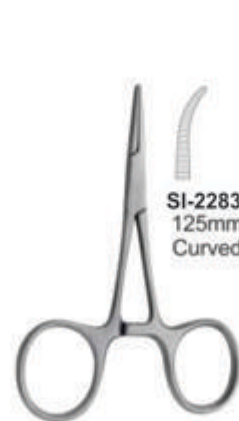

SI-2283
125mm
Curved

Hartmann (Baby Mosquito)
SI-2282 90mm straight



SI-2285
Curved

Halstead Mosquito
SI-2284 125mm
Straight

GUM SCISSORS

- Ножницы десневые
- Ciseaux a gencives
- Zahnfleischscheren
- Ножици для ясен
- Tijeras para encias
- مقص صمغ



SI-2286
Goldman Fox Scissors
12.5cm Curved



SI-2287
Iris Scissors
11.5cm Curved
Serrated For Slip-Free Cutting



SI-2288
LaGrange Scissors
11.5cm Double Curved
Serrated For Slip-Free Cutting

Double
Curved



SI-2289
Castroviejo Micro Scissors
12cm Curved



SI-2290
Super Cut Goldman Fox
13.2cm Curved
Serrated For Slip-Free Cutting



SI-2291
Super Cut Iris
11cm Straight
Serrated For Slip-Free Cutting



SI-2292
Super Cut Iris
11cm Curved
Serrated For Slip-Free Cutting

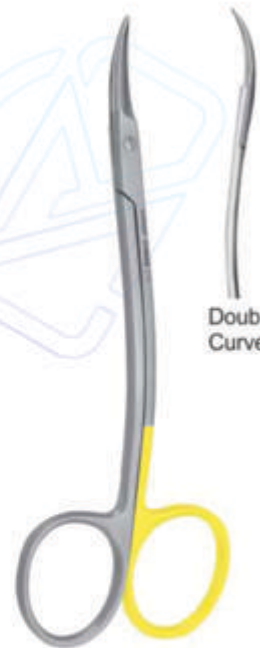

SI-2293
Super Cut LaGrange
11.5cm
Double Curved
Serrated For Slip-Free Cutting

Double
Curved

NEEDLE HOLDERS

- Иглодержатели
- Porte-aiguilles
- Nadelhalter

- Голкотримачи
- Porta-agujas
- اصحاب ابرة



SI-2294
Lichtenberg-
Ryder T.C
14 cm



SI-2295
Lichtenberg-
Ryder T.C
14 cm



SI-2296
Lichtenberg-
Ryder T.C
17 cm



SI-2297
Lichtenberg-
Ryder T.C
17 cm



SI-2298
Barraquer
18 cm



SI-2299
Barraquer
18 cm



SI-2300
Barraquer T.C
18 cm



SI-2301
Barraquer T.C
18 cm



SI-2302
Tönnis
18 cm



SI-2303
Castroviejo
13 cm
Straight



SI-2304
Kalt Needle Holders T.C
14 cm Straight



SI-2305
Peet Splinter Forceps
11.5 cm

SI-2306
La Grange
Curved



SI-2307
All-Purpose Pliers

HAEMOSTATIC FORCEPS & TOWEL CLAMPS

- Зажимы артериальные, зажимы для салфеток
- Pincas hemostatiques, Pincas a compresas
- Arterienklemmen, Tuyschklemmen
- Затискачі артеріальні, затискачі для серветок
- Pinzas hemostaticas, Pincas para compresas
- الملقط هيموستاتيک للشهک متشعبة

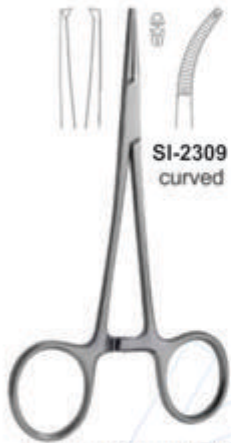

SI-2309
curved

Halstead Mosquito 1x2
SI-2308 125mm
straight



SI-2311
curved

Kelly
SI-2310 140mm
straight



SI-2315 140mm
SI-2316 160mm
SI-2317 180mm
SI-2318 200mm
curved

Rochester-Pean
SI-2311 140mm
SI-2312 160mm
SI-2313 180mm
SI-2314 200mm
straight



SI-2323 140mm
SI-2324 160mm
SI-2325 180mm
SI-2326 200mm
curved

Rochester-Kocher 1x2
SI-2319 140mm
SI-2320 160mm
SI-2321 180mm
SI-2322 200mm
straight



SI-2327
curved

SI-2327
Kelly-Rankin
160mm
straight



Lorna
SI-2329 100mm
SI-2330 130mm



SI-2331
Allis-Baby 3:4
150mm



SI-2332
Allis 4:5
200mm



SI-2333
Allis 6:7
200mm



Ball Socket
SI-2334 140mm
Not-perforating and
not-damaging



SI-2335
Backhaus
130mm



SI-2336
Backhaus
85mm



SI-2337
Jones
90mm



SI-2339
curved

Gross Maier
Dressing Forceps
SI-2338 200mm straight



Foerster
Dressing Forceps
SI-2340 200mm



Spare rubber

Young
Tongue Forceps
SI-2341 170mm



Collins
Tongue Forceps
SI-2342 170mm

RUBBER DAM CLAMPS FORCEPS

- Инструменты для системы коффердам
- Pinces porte-crampons a dique
- Kofferdam Klammerzangen
- Инструменти для системи коффердам
- Pinzas de engrapar para dique de caucho
- السد العطاء الملقط المشابك



SI-2343

On request the Content of the rubber dam kit can be changed with other instruments.

Content:

- 01 Anisworth
- 02 Brewer
- 03 Clamps Stand
- 04 Denture Plate
- 05 Rubber Dam Frame
- 06 Rubber Dam Box Lower Case
- 07 Rubber Dam Box Upper Case
- 08 Rubber Dam Clamp Fig. 212
- 09 Rubber Dam Clamp Fig. 211
- 10 Rubber Dam Clamp Fig. 8
- 11 Rubber Dam Clamp Fig. 8A
- 12 Rubber Dam Clamp Fig. 14
- 13 Rubber Dam Clamp Fig. 14A
- 14 Rubber Dam Clamp Fig. 0
- 15 Rubber Dam Clamp Fig. 00
- 16 Rubber Dam Clamp Fig. 2
- 17 Rubber Dam Clamp Fig. 2A
- 18 Rubber Dam Clamp Fig. 7

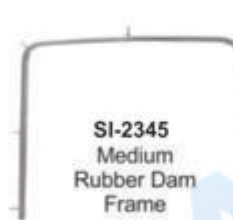
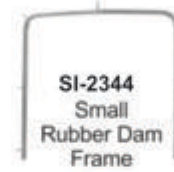

SI-2347
Brewer



SI-2348
Stockes



SI-2349
Palmer



SI-2350
Ivory light weight



SI-2351
Anisworth



SI-2352
Anisworth



Punch Plier



SI-2353
Anisworth



SI-2354
Ivory



SI-2355
Separating
Elastic Plier

RUBBER DAM CLAMPS KITS

- Резиновая дамба зажимы комплекты
- Trousses de caoutchouc
- Gummidammklammern
- Гумова дамба затискачі комплекти
- Conjuntos de abrazaderas de retención de caucho
- المطاط السد المشابك مجموعات



SI-2356

Stainless Steel Gold Plated Rubber Dam Clamp Tray with 11 Different Clamps
Fig. 212, 211, 8, 8A, 14, 14A, 0, 00, 2, 2A, 7



SI-2357

Stainless Steel Rubber Dam Clamp Tray with 12 Different Clamps
Fig. 209, 212, 211, 8, 8A, 14, 14A, 0, 00, 2, 2A, 7



SI-2358

Stainless Steel Rubber Dam Clamp Tray with 8 Different Clamps
Fig. 1, 26, 29, 51, 60, 202, 205, 210



SI-2359

Stainless Steel Rubber Dam Clamp Tray
(without clamps)



SI-2360

On request the Content of the rubber dam kit can be changed with other instruments.

Content:

- | | |
|------------------------------|------------------------------|
| 01 Ivory | 08 Rubber Dam Clamp Fig. 209 |
| 02 Ivory light weight | 09 Rubber Dam Clamp Fig. 212 |
| 03 Clamps Stand | 10 Rubber Dam Clamp Fig. 211 |
| 04 Rubber Dam Frame M | 11 Rubber Dam Clamp Fig. 8 |
| 05 Rubber Dam Frame L | 12 Rubber Dam Clamp Fig. 8A |
| 06 Rubber Dam Box Lower Case | 13 Rubber Dam Clamp Fig. 14 |
| 07 Rubber Dam Box Upper Case | 14 Rubber Dam Clamp Fig. 14A |
| | 15 Rubber Dam Clamp Fig. 0 |
| | 16 Rubber Dam Clamp Fig. 00 |
| | 17 Rubber Dam Clamp Fig. 2 |
| | 18 Rubber Dam Clamp Fig. 2A |
| | 19 Rubber Dam Clamp Fig. 7 |

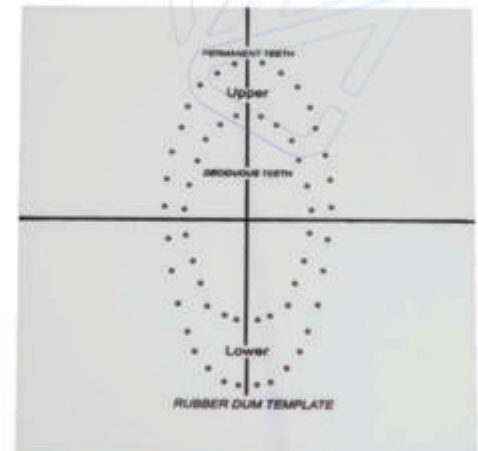

SI-2361

Rubber Dum Template

RUBBER DAM CLAMPS

- Кляммера для коффердама
- Crampons pour digue
- Kofferdam Klammern
- Кляммера для коффердама
- Grapas para dique de caucho
- المشابك السد المطاط



SI-2362
Fig. 15



SI-2363
Fig. 18



SI-2364
Fig. 24



SI-2365
Fig. 25



SI-2366
Fig. 26



SI-2367
Fig. 28



SI-2368
Fig. 30



SI-2369
Fig. 31



SI-2370
Fig. 51



SI-2371
Fig. 138



SI-2372
Fig. 139



SI-2373
Fig. 200



SI-2374
Fig. 201



SI-2375
Fig. 202



SI-2376
Fig. 203



SI-2377
Fig. 204



SI-2378
Fig. 205



SI-2379
Fig. 3



SI-2380
Fig. W3



SI-2381
Fig. 4



SI-2382
Fig. 56A



SI-2383
Fig. 7



SI-2384
Fig. 7A



SI-2385
Fig. 8



SI-2386
Fig. 8A



SI-2387
Fig. W8A



SI-2388
Fig. 10



SI-2389
Fig. 11



SI-2390
Fig. 12A



SI-2391
Fig. 13A



SI-2392
Fig. 14



SI-2393
Fig. 14A



SI-2394
Fig. 14AN



SI-2395
Fig. 22



SI-2396
Fig. 27



SI-2397
Fig. 207



SI-2398
Fig. 29



SI-2399
Fig. 206



SI-2400
Fig. 208



SI-2401
Fig. 209



SI-2402
Fig. 1



SI-2403
Fig. 1A



SI-2404
Fig. 2



SI-2405
Fig. 2A



SI-2406
Fig. W2A



SI-2407
Fig. 0



SI-2408
Fig. 00



SI-2409
Fig. 210



SI-2410
Fig. 211



SI-2411
Fig. 212



SI-2412
Fig. 6



SI-2413
Fig. 9



SI-2414
Fig. N06



SI-2415
Fig. U67



SI-2416
Fig. 214



SI-2417
Fig. P1



SI-2418
Fig. P2



SI-2419
Fig. G-1



SI-2420
Fig. G-2



SI-2420
Fig. G-2

CROWN REMOVER

- Инструменты для удаления коронок
- Arrache-couronnes
- Teleskopkronenzangen
- Инструменты для видалення коронок
- Arranca-corona
- مزيلات التاج



SI-2421
Crown Spreaders



SI-2421
Universal
Fig. 0



Manual Crown Removers
Handle with 3 tips DE-1551
Only 3 tips SI-2422 to SI-2424



SI-2422 SI-2423



SI-2424



Manual Crown Removers
Handle with 3 tips DE-1555
Only 3 tips SI-2425 to SI-2427



SI-2425 SI-2426



SI-2427



SI-2428
Manual Crown
Remover



SI-2429
Manual Crown Remover



SI-2430
Complete with 3 tips
and tightening keys

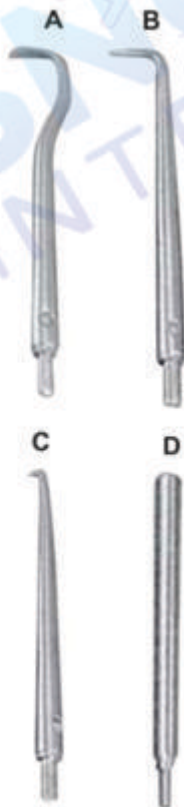

semi-automatic crown
& bridge remover



SI-2431



A B

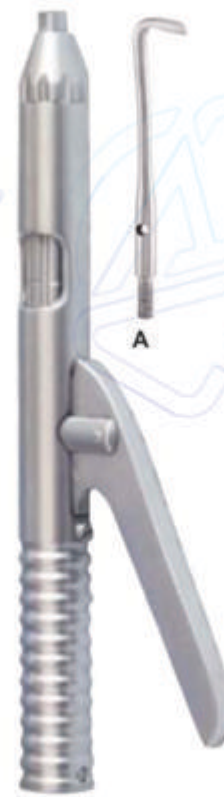

SI-2432
Manual Crown Remover



A B C



D E

MATRIX RETAINERS

- Матрицедержатели
 - Porte Matrices
 - Matrizenspanner
- Матрицеутримувачи
 - Porta Matrices
 - مصفوفة الخدم



SI-2433
Fig. 5
Ivory 8
5 cm



SI-2432
Fig. 6
Ivory 8
6 cm



SI-2433
Fig. 7
Ivory 8
7 cm



SI-2434
Fig. 1
Tofflemire-Universal



SI-2435



SI-2436



SI-2437

Siqveland Retainers



SI-2438
Fig. 2
Tofflemire-Junier



SI-2439
Fig. 3
Tofflemire-Senior



SI-2440
Narrow



SI-2441
Wide

Amalgam Well



SI-2442
Stainless Steel
Amalgam Well



SI-2443
Ivory 12



SI-2444
Ivory 1



SI-2445
Ivory



SI-2446
Elliot

AMALGAM INSTRUMENTS

- Инструменты для амальгамы
- Instruments pour amalgame
- Amalgamisinstrumente
- Инструменти для амальгами
- Instrumentos para amalgama
- الصكوك الملقف



SI-2447
Fig. 10
165mm
English pattern



SI-2448
Fig. 1
185mm
German pattern



SI-2449
Fig. 1
150mm
Swiss pattern



SI-2450
Fig. 1
150mm



SI-2451
Fig. 2
150mm, 45°



SI-2452
Fig. 3
140mm, 90°



SI-2453
Chip Blower



SI-2454



SI-2455



SI-2456



SI-2457
Water Syringe

AMALGAM INSTRUMENTS

- Инструменты для амальгамы
 - Instruments pour amalgame
 - Amalgamis/instrumente
- Инструменты для амальгамы
 - Instrumentos para amalgama
 - الصكوك المنقر

AMALGAM CARRIERS

TIP SIZES FOR DISTAL OR SINGLE-END

1.5 mm



SI-2459
Mini/
Single-End

2.0 mm



SI-2460
Regular
Single-End

2.8 mm



SI-2461
Large
Single-End

1.5 mm



SI-2462
Mini
Distal

2.0 mm



SI-2463
Regular
Distal

TIP SIZES FOR DOUBLE-END

1.5 mm



2.0 mm
SI-2464
Mini/
Regular

2.8 mm



2.0 mm
SI-2465
Large/
Regular

3.2 mm



2.0 mm
SI-2466
Jumbo/
Regular

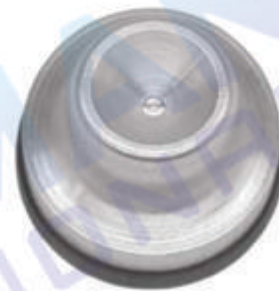

SI-2467
Amalgam
Well

SI-2458
Single-End

TIP SIZES FOR DOUBLE-END

SI-2468 - 1.5mm-2.0mm	SI-2471 - 1.0mm-2mm
SI-2469 - 2.0mm-2.8mm	SI-2472 - 2.0mm-3mm
SI-2470 - 2.0mm-3.2mm	SI-2473 - 2.0mm-4mm

SI-2474 - 1.5mm-2.0mm	SI-2477 - 1.0mm-2mm
SI-2475 - 2.0mm-2.8mm	SI-2478 - 2.0mm-3mm
SI-2476 - 2.0mm-3.2mm	SI-2479 - 2.0mm-4mm

SI-2480 - 1.5mm-2.0mm	SI-2483 - 1.0mm-2mm
SI-2481 - 2.0mm-2.8mm	SI-2484 - 2.0mm-3mm
SI-2482 - 2.0mm-3.2mm	SI-2485 - 2.0mm-4mm

SI-2486 - 1.5mm-2.0mm	SI-2489 - 1.0mm-2mm
SI-2487 - 2.0mm-2.8mm	SI-2490 - 2.0mm-3mm
SI-2488 - 2.0mm-3.2mm	SI-2491 - 2.0mm-4mm

SI-2491 - 1.5mm
SI-2493 - 2.0mm
SI-2494 - 2.0mm
SI-2495 - 3.0mm



ROOT PLANNING FILES



SI-2508
Kramer-Nevins
Bone Chisel



SI-2509
Kramer-Nevins
Bone Chisel



SI-2510
Molt 18.5cm
Auto Clavable
Plastic Tips.



SI-2511
Mead 18.5cm
Non Auto Clavable
Plastic Tips.



SI-2512
Miller



SI-2513
Miller

BONE FILES



SI-2514
Miller 21



SI-2515
Miller 1X
cross cut



SI-2516
Miller 2X
cross cut



SI-2517
Miller 52



SI-2518
Wahl 1

PERIODONTAL INSTRUMENTS

- Инструменты пародонтологические
- Instruments pour la parodontologie
- Instrumente für die Parodontologie
- Інструменти пародонтологічні
- Instrumentos para periodoncia
- الصكوك اللثة

PERIOSTEEL ELEVATORS



SI-2519 Ohi 10 SI-2520 Howard 9H SI-2521 Freer SI-2522 Freer 15 SI-2523 Freer 16 SI-2524 SI-2525 Raspator, Raspatory Length 175 mm SI-2526



SI-2527 SI-2528 DE-1662 Partsch 140 mm Partsch 170 mm Partsch 140 mm Partsch 170 mm

Raspator, Williger
Length 170 mm, different widths
(4 mm, 5 mm or 7 mm)

SI-2530 3mm SI-2534 3mm SI-2538 3mm SI-2542 3mm
 SI-2531 4mm SI-2535 4mm SI-2539 4mm SI-2543 4mm
 SI-2532 5mm SI-2536 5mm SI-2540 5mm SI-2544 5mm
 SI-2533 6mm SI-2537 6mm SI-2541 6mm SI-2545 6mm

PERIODONTAL INSTRUMENTS

- Инструменты пародонтологические
- Instruments pour la parodontologie
- Instrumente für die Parodontologie
- Инструменти пародонтологічні
- Instrumentos para periodoncia
- الصكوك الثلاثة

To separate tissue tooth or bone. tp hold tissue away from surgical site.

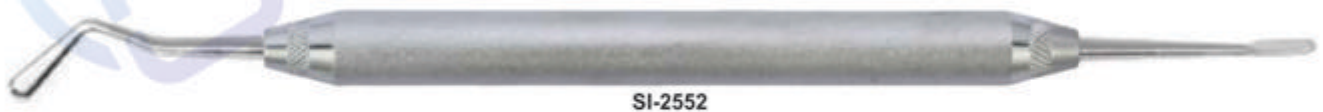
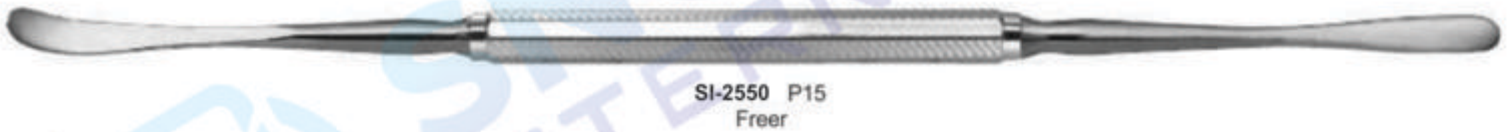
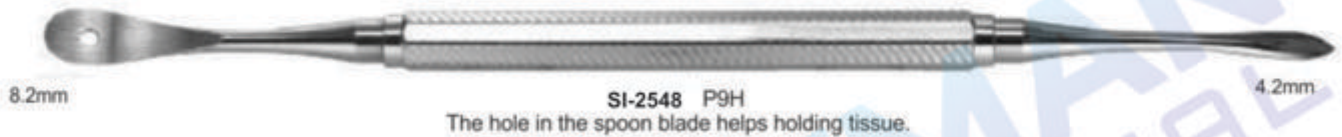
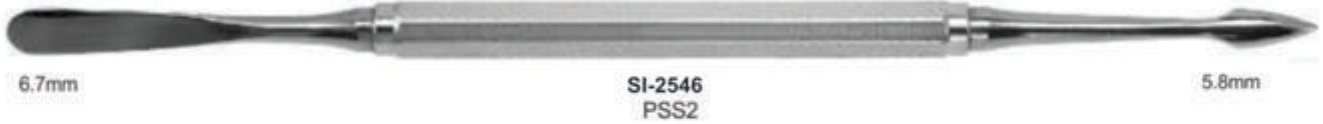

PERIODONTAL INSTRUMENTS

- Инструменты пародонтологические
- Instruments pour la parodontologie
- Instrumente für die Parodontologie
- Инструменти пародонтологічні
- Instrumentos para periodoncia
- الصكوك اللثة



SI-2556



SI-2557
P24G

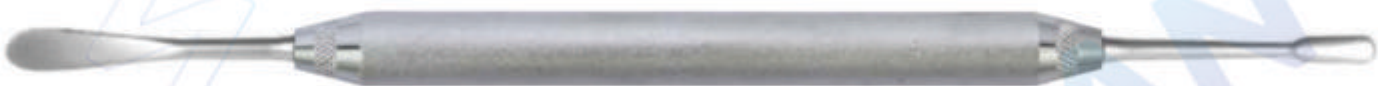

SI-2558
titanium Periosteal Elevator for Implan5



SI-2559
S1



SI-2560
Hirschfeld



SI-2561
9S



10mm

SI-2562
Selden

13mm

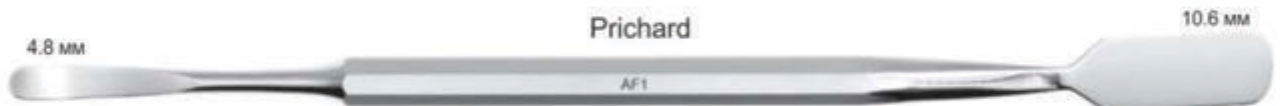

4.8 mm

Prichard

10.6 mm

SI-2563
Friedmann



SI-2564
Schmidlin

6.9 mm

SCALPEL HANDLES

- Ручки для скальпелей
- Manches de bistouris
- Skalpellgriffe
- Ручки для скальпелів
- Mangos de bisturi
- مشرط مقابض



SI-2565
Fig.3
12.7cm



SI-2566
Fig.3G
12.7cm



SI-2567
Fig.4
13.7cm



SI-2568
Double Handle
No.4 + No.3
16.3cm



SI-2569
Fig. 7
16.5cm



SI-2570
Scalpel Handle Straight
for blades #10-15
14.5cm



SI-2571
Micro Surgical Scalpel
Handle titanium
13.5cm



SI-2572
Fig. 5
14.5cm



SI-2573
Fig. 5A
14.5cm



SI-2574
6 Way Adjustable Angled
Scalpel Handle



SI-2575
Metal tip
220 mm
Hammer With Wooden Handle



SI-2576
Metal tip
220 mm



SI-2577 1 For plaster
SI-2578 2 For metal



SI-2579
Fret saw
250 mm



SI-2580
Small
Saw Blades



SI-2581
Large
Saw Blades



SI-2582
Ceri Saw



Special Inox
SI-2583 170mm
SI-2584 200mm



SI-2585
Plaster Shears
200 mm



Crucible Tongs
SI-2586 250 mm
SI-2587 320 mm



SI-2588
Ceri Saw
180 mm



SI-2589
Blade
0,12x5 mm
Conf. 12 pcs



SI-2590
Blade
0,25x5 mm
Conf. 12 pcs



SI-2591
Blade
0,25x3 mm
Conf. 12 pcs



Behind Every Smile is a Story

- QUALITY - ЯКІСТЬ
- PRECISION - ТОЧНІСТЬ
- ACCURACY - ПРАВИЛЬНІСТЬ
- DURABILITY - ЗНОСОСТІЙКІСТЬ



ORTHODONTIC INSTRUMENTS

- Инструменты ортодонтические
- Instrumentos Ortodonticos
- Orthodontische Instrumente
- Инструменти ортодонтични
- Instruments Orthodontiques
- أدوات تقويم الأسنان



SI-2592
Height Gauge 0.18
Aluminum



SI-2593
Height Gauge 0.22
Aluminum



SI-2594
Height Gauge 0.18
Stainless Steel



SI-2595
Height Gauge 0.22
Stainless Steel



SI-2596
Moveable
Height Gauge



SI-2597
Endo Finger
Ruler Span
Measure Scale



SI-2598
Endo Finger
Ruler Span
Measure Scale



SI-2599
Endo Finger
Ruler Span
Measure Scale



SI-2601
Positive
Postioner



SI-2602
Strip Saw



SI-2603
Bone Bracket Gauge



SI-2600
Endo Finger Ruler
Span Measure Scale



SI-2604
Endo Finger Ruler
Span Measure Scale

- Инструменты ортодонтические
- Instrumentos Ortodonticos
- Orthodontische Instrumente
- Инструменти ортодонтични
- Instruments Orthodontiques
- أدوات تقويم الأسنان



SI-2605
Measuring Loop
angled, length
175 mm,
measuring range
0 - 40 mm



SI-2606
Measuring Loop
straight length
175 mm,
measuring range
0 - 40 mm



SI-2607
Measuring loop, Castroviejo
angled, length 175 mm,
measuring range 0 - 40 mm,
with window



SI-2608
Measuring Loop
straight length 90 mm,
measuring range
0 - 40 mm,

SI-2609
Castroviejo Calipers
20mm
90mm



SI-2610
Measuring Loop
angled, length 90 mm,
measuring range
0 - 40 mm,

SI-2611
Castroviejo Calipers
20mm, 45°
90mm



SI-2612
Castroviejo Calipers
20mm
90mm



SI-2613
Fig. 1
Iwanson
spring caliper
For metal and
porcelain.



SI-2614
Fig. 2
Iwanson
spring caliper
For wax.

ORTHODONTIC INSTRUMENTS

- Инструменты ортодонтические
- Instrumentos Ortodonticos
- Orthodontische Instrumente
- Инструменти ортодонтични
- Instruments Orthodontiques
- أدوات تقويم الأسنان



SI-2615
Boley Gauge



SI-2616
Vernier Gauge



SI-2617
Aluminium Caliper
up to 200mm



SI-2618
Boley Gauge



SI-2619
Delux Boley
Gauge



SI-2620
Beerendonk
130mm
Mini Gauge



SI-2621
Compasso
De Willis



SI-2622
Dentaurum
Ruler



SI-2623
Ruler Wedge



SI-2624
Ruler

- Инструменты ортодонтические
- Instrumentos Ortodonticos
- Orthodontische Instrumente
- Инструменти ортодонтични
- Instruments Orthodontiques
- أدوات تقويم الأسنان

Bracket Holder Tweezers



SI-2625
Deluxe Bracket
Holder Tweezers



SI-2626
Deluxe Bracket
Holder Tweezers



SI-2627
Direct Bond Bracket
Holder Tweezers



SI-2628
Bracket Tweezers
Slot Aligner



SI-2629
Direct Bond
Bracket Holder
Tweezers, Small Tip



SI-2630
Exact Bracket
Holder Tweezers



SI-2631
Bracket Placing
Tweezers



SI-2632
Easy Access
Tweezers



SI-2633
Bracket Placer
Tweezers
(Extra Fine Tip)



SI-2634
Deluxe Bracket
Holder Tweezers
135mm



SI-2635
Easy Access
Tweezers



SI-2636
Slipper
Tweezers



SI-2637
Direct Bonding
Bracket Holders
135mm



SI-2638
Direct Bonding
Bracket Holders
136mm



SI-2639
Direct Bonding
Bracket Holders
135mm



SI-2640
Deluxe Bracket
Holder



SI-2641
Direct Bonding
Bracket Holders
140mm

ORTHODONTIC INSTRUMENTS

- Инструменты ортодонтические
 - Instrumentos Ortodonticos
 - Orthodontische Instrumente
- Инструменти ортодонтични
 - Instruments Orthodontiques
 - أدوات تقويم الأسنان



SI-2642
Band seater
auto cleavable



SI-2643
Band seater
auto cleavable
Triangle Shape



SI-2644
Band seater
auto cleavable
Square Shape



SI-2645
Band seater
auto cleavable
Round Shape



SI-2646
Mershon Band
Pusher
140mm



SI-2647
Band seating &
removing
instruments



SI-2648
Ortho Light double
ended
ligature director
scaler



SI-2649
Ortho Light Band
Pusher Scaler



SI-2650
Band Seating &
Removing
Silicon Grip



SI-2651
Ligature Instrument
Silicon Grip



SI-2652
Elastic Instrument
Silicon Grip



SI-2653
Distal Bender
Silicon Grip



SI-2654
Distal Bender
Silicon Grip



SI-2655
Distal Bender
Silicon Grip

- Инструменты ортодонтические
- Instrumentos Ortodonticos
- Orthodontische Instrumente
- Инструменти ортодонтични
- Instruments Orthodontiques
- اوتوات تقويم الأسنان



SI-2656
Ortho light scaler double ended



SI-2657
Ortho light scaler double ended



SI-2658
Ortho light scaler double ended



SI-2659
Twiel-on elastic module instrument



SI-2660
Twiel-on elastic module instrument



SI-2661
Schure Band Seater



SI-2662
Ortho light scaler



SI-2663
Ortho light scaler



SI-2664
Ortho light scaler heavy



SI-2665
Ortho instrument



SI-2666
Ortho instrument

ORTHODONTIC INSTRUMENTS

- Инструменты ортодонтические
- Instrumentos Ortodonticos
- Orthodontische Instrumente
- Инструменти ортодонтични
- Instruments Orthodontiques
- اذوات تقويم الأسنان



SI-2667
Ortho Light double ended
ligature director



SI-2668
Ortho Light double ended ligature scaler director tivate coil spring
are remove modules with one instruments



SI-2669
Ortho band pusher scaler



SI-2670
Ortho ligature director single ended



SI-2670
Ortho Light double ended ligature
director scaler



SI-2671
Ortho Light double ended ligature scaler/director
tivate coil spring are remove modules with one instruments



SI-2672
Ortho Light double ended ligature director



SI-2673
Ortholite Ligature Director Scaler



SI-2674
Ortho light ligature director double ended



SI-2675
Double ended cement spatula



SI-2676
Ortho light scaler single ended

- Щипцы для ортодонтии и протезирования
- Pincers pour l'orthodontie et la prothèse
- Zangen für Kieferorthopädie und Prothetik
- Щипці для ортодонції та протезування
- Alicates para ortodoncia y prótesis
- كمشة لتقويم الأسنان بروسٹیتس

BOX JOINT PLIERS

SI-2677
Universal Dolphin Style
Wire Bending & cutting pliers



SI-2683
Bracket Removing Plier curved
Bracket Removing Plier curved for
easy removal of brackets in the
posterior region. Length 130mm



SI-2678 Band Removing Plier
The curved blade of the band
removing plier can strip easily
and gently remove directly to
the tooth. Length 130mm



SI-2684
Young Wire Bending &
Loop Forming Pliers



SI-2679
Tweed Loop
forming Pliers



SI-2685
Wire Bending &
Loop Forming Pliers



SI-2680
How Plier curved
Universally usable tool for
the multiband technology for
wires up to .028".
Length 130mm



SI-2686
Adams, small wire bending
and loop forming Pliers



SI-2681 How Plier
Universally usable tool for the
multiband technology for wires
up to .028".
Length 135mm



SI-2687
Bracket Removing Plier Round Box
Bracket removing plier for comfortable
and quick removal of the brackets.
Length 135mm



SI-2682
Nance Loop
forming Pliers



SI-2688
Weingart Plier medium
Weingart plier that are ideal due to
their curved plier for setting sheets and
is capable of bending the ends.
Length 145mm



PLIERS FOR ORTHODONTICS & PROSTHETICS

- Щипцы для ортодонтии и протезирования
- Pincers pour l'orthodontie et la prothèse
- Zangen für Kieferorthopädie und Prothetik
- Щипці для ортодонції та протезування
- Alicates para ortodoncia y prótesis
- كمانة لتقويم الأسنان بروسلیکس

BOX JOINT PLIERS

SI-2689 Adams Plier Round Box
Adams pliers for bending wire arches and bends right angles for wires up to .022", .025 tip to beak. Length 125mm



SI-2695 Adams Plier
Adams pliers for bending wire arches and bends right angles for wires up to .022", .025 tip to beak. Length 125mm



SI-2690 Falcon Beak Contouring Pliers.



SI-2696 Tweed Loop Formin Pliers



SI-2691
wires up to 0.020" / 0.7mm.



SI-2697 Bird Beak Plier Standard
Bird Beak Wire bending plier without notches, which is suitable as a universal utility tool. Length 125mm



SI-2692 Johnson Contouring Pliers



SI-2698 Mini Ligature cutters



SI-2693 Aderer
Large wire bending and loop forming pliers



SI-2699 Small Fluch-cut distal and cutting Pliers
with safety hold fitted with un-breakable, corrosion resistant and durable stainless steel tips



SI-2694 Tweed / angle rectangular arch forming & Torquing pliers



SI-2700 Large Fluch-cut distal and cutting Pliers
with safety hold fitted with un-breakable, corrosion resistant and durable stainless steel tips



- Щипцы для ортодонтии и протезирования
- Pincers pour l'orthodontie et la prothèse
- Zangen für Kieferorthopädie und Prothetik
- Щипці для ортодонції та протезування
- Alicates para ortodoncia y prótesis
- מכשירי לטיפול ברושמים

BOX JOINT PLIERS

SI-2701

Tweed / Angel

1.78mm (.070") wide tips arch forming and torquing pliers



SI-2707

Contouring Plier



SI-2702

Tweed / Angel

1.78mm (.070") wide tips arch forming and torquing pliers



SI-2708

Bands & Crowns Plier
in order to skirt



SI-2703

Lingual / Palatal arch
forming pliers



SI-2709

Ligature Forming Pliers



SI-2704

Aderer

Facebow loop forming Pliers



SI-2710

for double back and triple back bands in 0.30" / 0.76mm & 0.36" / 0.91mm lingual arch wires



SI-2705

Waldsavhs wire bending and cutting pliers



SI-2711

Bird Beak Wire Bending & cutting pliers



SI-2706 **Aderer Plier**

For the manufacturing of appliances and activation of wires for wires up to .030" .fine tip and up to .036" mean tip. Length 130mm



SI-2712

Weingart Plier medium

Weingart plier that are ideal due to their curved tip for setting sheets and is capable of bending the ends. Length 145mm



PLIERS FOR ORTHODONTICS & PROSTHETICS

- Щипцы для ортодонтии и протезирования
- Pincers pour l'orthodontie et la prothèse
- Zangen für Kieferorthopädie und Prothetik
- Щипці для ортодонції та протезування
- Alicates para ortodoncia y prótesis
- كمشة لتقويم الأسنان بروسٹیٹس

L-KEY JOINT PLIERS



SI-2713
Distal end cutter with safety hold, mini head, long handles, fitted with un-breakable, corrosion resistant and durable stainless steel tips

- 0.30 mm to 0.50 mm (.012" to .020")
- Max. 0.46 mm x 0.64 mm (.018" x .025")
- ⊗ 0.38 mm to 0.53 mm (.0155" to .0215")
- ⊗ Max. 0.53 mm x 0.64 mm (.021" x .025")



SI-2714
Flush-cut distal end cutter with safety hold fitted with un-breakable, corrosion resistant and durable stainless steel tips

- 0.30 mm to 0.50 mm (.012" to .020")
- Max. 0.46 mm x 0.64 mm (.018" to .025")



SI-2715
Soft wire and ligature cutter, Mini fitted with un-breakable, corrosion resistant and durable stainless steel tips

- ⌋ .25 mm to .38 mm (.010" to .015")



SI-2716
Soft wire and ligature cutter, standard fitted with un-breakable, corrosion resistant and durable stainless steel tips

- ⌋ .25 mm to .38 mm (.010" to .015")



SI-2717
Soft wire and ligature cutter, 15° angled fitted with un-breakable, corrosion resistant and durable stainless steel tips

- ⌋ .25 mm to .38 mm (.010" to .015")



SI-2718
Soft wire and ligature cutter, 45° angled fitted with un-breakable, corrosion resistant and durable stainless steel tips

- ⌋ .25 mm to .38 mm (.010" to .015")



SI-2719
Hard wire cutter, straight Fitted with un-breakable, corrosion resistant and durable stainless steel tips

- 0.30 mm to 0.50 mm (.012" to .020")
- Max. 0.56 mm x 0.71 mm (.022" x .028")



SI-2720
Hard wire cutter, 15° angled Fitted with un-breakable, corrosion resistant and durable stainless steel tips

- 0.30 mm to 0.50 mm (.012" to .020")
- Max. 0.56 mm x 0.71 mm (.022" x .028")



SI-2721
Hard wire cutter, 15° angled Non-autoclavable

- 0.30 mm to 0.50 mm (.012" to .020")
- Max. 0.56 mm x 0.71 mm (.022" x .028")

- Щипцы для ортодонтии и протезирования
- Pincers pour l'orthodontie et la prothèse
- Zangen für Kieferorthopädie und Prothetik
- Щипці для ортодонції та протезування
- Alicates para ortodoncia y prótesis
- كمشة لتكويم الأسنان بروسٹیس

L-KEY JOINT PLIERS



SI-2722
Band removing pliers



SI-2727
Weingart-mini
Utility Pliers

- 0.30 mm to 0.50 mm (.012" to .020")
- Max 0.56 mm x 0.71 mm (.022" x .028")



SI-2723
Bracket removing pliers angled



SI-2728
Weingart
Utility Pliers

- 0.30 mm to 0.50 mm (.012" to .020")
- Max 0.56 mm x 0.71 mm (.022" x .028")



SI-2724
Bracket removing pliers straight



SI-2729
How Straight
Utility Pliers

- 0.30 mm to 0.50 mm (.012" to .020")
- Max 0.56 mm x 0.71 mm (.022" x .028")



SI-2725
Bracket removing pliers with plastic tip



SI-2730
Angled
Utility Pliers

- 0.30 mm to 0.50 mm (.012" to .020")
- Max 0.56 mm x 0.71 mm (.022" x .028")



SI-2726
Adhesive removing pliers



SI-2731
Wire bending and loop forming pliers
Angled (Bird beak)

- 0.30 mm to 0.50 mm (.012" to .020")
- Max 0.56 mm x 0.71 mm (.022" x .028")

PLIERS FOR ORTHODONTICS & PROSTHETICS

- Щипцы для ортодонтии и протезирования
- Pincers pour l'orthodontie et la prothèse
- Zangen für Kieferorthopädie und Prothetik
- Щипці для ортодонції та протезування
- Alicates para ortodoncia y prótesis
- كماناتة لتقويم الاسنان بروتستيس

L-KEY JOINT PLIERS



SI-2732
Multi-purpose pliers, bird beak,
De la rosa and cutter in one

- 0.30 mm to 0.50 mm (.012" to .020")
- Max. 0.46 mm x 0.56 mm (.018" x .022")



SI-2737
Stop pliers V-Bebd - 1mm

- 0.30 mm to 0.50 mm (.012" to .020")
- Max. 0.43 mm x 0.56 mm (.017" x .028")



SI-2733
Cinch Back / tie back
Distal end bending pliers

- 0.30 mm to 0.50 mm (.012" to .020")
- Max. 0.56 mm x 0.71 mm (.022" x .028")

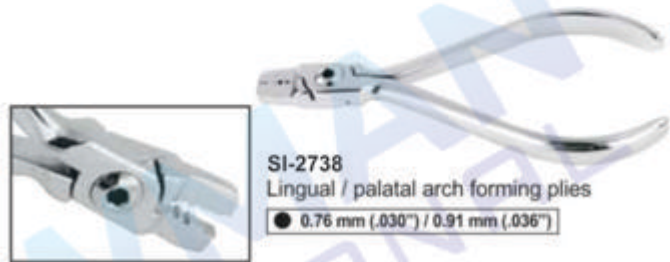

SI-2738
Lingual / palatal arch forming plies

- 0.76 mm (.030") / 0.91 mm (.036")



SI-2734
Hammer head
Distal end bending pliers

- 0.30 mm to 0.50 mm (.012" to .020")
- Max. 0.56 mm x 0.71 mm (.022" x .028")



SI-2739
Torquing pliers set

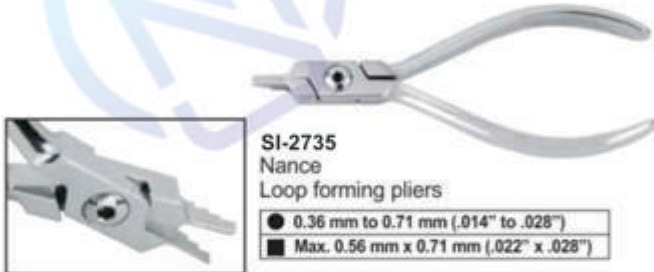

SI-2735
Nance
Loop forming pliers

- 0.36 mm to 0.71 mm (.014" to .028")
- Max. 0.56 mm x 0.71 mm (.022" x .028")



SI-2740
Tweed / angel
Rectangular arch forming and
torquing pliers

- 0.30 mm to 0.71 mm (.012" to .028")
- Max. 0.56 mm x 0.71 mm (.022" x .028")



SI-2736
Detailing step pliers / Bayonet
bending pliers - 1mm

- 0.30 mm to 0.50 mm (.012" to .020")
- Max. 0.56 mm x 0.71 mm (.022" x .028")



SI-2741
Surgical ball hook crimping pliers,
angled



SI-2742
Surgical ball hook crimping
pliers, straight

- Щипцы для ортодонтии и протезирования
- Pincettes pour l'orthodontie et la prothèse
- Zangen für Kieferorthopädie und Prothetik
- Щипці для ортодонції та протезування
- Alicates para ortodoncia y prótesis
- كمشة لتكويم الأسنان بروتستیس

L-KEY JOINT PLIERS



SI-2743
Aderer Clamp three jaw wire bending plier for contouring and bending wire up to .30"/.76mm.

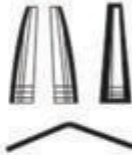

SI-2749
Falcon beak contouring plier.

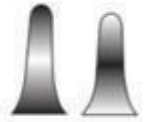

SI-2744
Bird beak plier for bending round, square and rectangle wire up to .30"/.76mm.

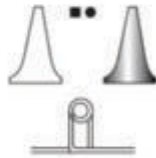

SI-2750
For placement and removal of arch wires, pins and other auxiliaries.



SI-2745
Bird beak plier for light wire bending round, square and rectangular up to .016"/0.41mm.

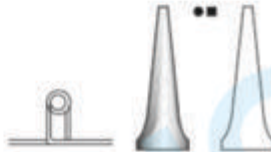

SI-2751
For placement and removal of arch wires, pins and other auxiliaries in angle design



SI-2746
Double Rounded jaw bending pliers, hooks and wire up to .020"/0.51mm.

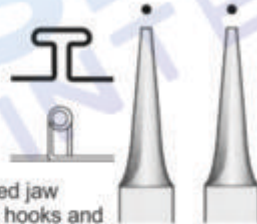

SI-2752
contouring Plier.



SI-2753
Bending plier. In order to skirt molares bands. With grooved. Recommended wire. 016", 018" and 022" 0.41mm, 0.46mm and 0.56mm



SI-2747
Adams pliers for hooks and bending wire up to .030"/0.76mm.



SI-2754
Loop forming in four length 3, 4, 5 & 6 mm wire capacity 0.22", 56mm.



SI-2748
Johnson pliers for crown band contouring



SI-2755
Arch bending plier design for convenient handling of square or rectangular wire, .020" / 0.51mm.



PLIERS FOR ORTHODONTICS & PROSTHETICS

- Щипцы для ортодонтии и протезирования
- Pincers pour l'orthodontie et la prothèse
- Zangen für Kieferorthopädie und Prothetik
- Щипці для ортодонції та протезування
- Alicates para ortodoncia y prótesis
- كمانة لتقويم الأسنان بروستھتیس

LAP & L-KEY JOINT PLIERS



SI-2756
In order to skirt bands and crowns.



SI-2757
Wires up to .020" / 0.7mm.

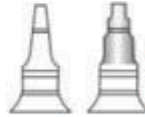

SI-2758
Round and concave plier for loop forming and banding wire up to .020" / .051mm.



SI-2759
Bending for round square or rectangular wire up to 0.30"/0.76mm



SI-2760
for double back and triple back bands in 0.30" / .76mm & 0.36" / .91mm lingual arch wires.



SI-2761
Detailing step plier double-sided offset beak permits bayonet bends. Creates right hand or left hand step-up or stepdown at 1/8, 1/4, or 1mm increments.



SI-2762
"V" bend stop special design makes 1mm "v" bends to shorten archwires or provide a positive stop. Excellent for placing stops in titanium wires. For round or rectangular wires up to .025"



SI-2763
Angle how plier efficient utility plier with serrated beaks for a firm grip. 45 angled tips to access hard to reach areas.



SI-2764
Weingardt plier serrated tips hold wires firmly at a convenient working angle. Tapered beaks fit easily between brackets and hard to reach areas. Our most popular utility plier.



SI-2765
Pin & Ligature Cutters TC.



SI-2766
Mini Pin & Ligature Cutter TC.



SI-2767
Standard Ligature Cutter TC.



SI-2768
V Bend Stop Plier TC.



SI-2769
Angled Direct Bond Bracket Remover TC.



SI-2770
Cutter Str.



Distal Cutter
14cm
SI-2771 2.5 mm
SI-2772 3.0 mm
SI-2773 3.0 mm



SI-2774
Arrow Clasp Forming Pliers
12.0cm



SI-2775
Schwarz
12.5cm

SI-2776
Distal end Cutter, Safety Hold Plier
(Ideal for Cutting Wire) TC.



SI-2777
Hook Crimping Plier Angled
Straight TC.



SI-2778
3 Prong Clasp Adjustable
Plier TC.



SI-2779
Utility Plier Weingart TC.



SI-2780
Direct Bracket Remover
TC.



SI-2781
Straight Direct Bond Bracket
Remover TC.



SI-2782
Pin Holding Plier TC.



SI-2783
Hard wire cutters



SI-2784
Elastic Separating Plier
Round Handle



SI-2785
Elastic
Separating Plier



SI-2786 Str.
SI-2787 Cvd.
Smaha
Elastomeric
ligature
placing forceps
140 mm



SI-2788
Elastomeric
ligature placing
forceps with
groove
Falcon 140 mm



SI-2789
Elastomeric
ligature placing
forceps with
groove
Falcon 140 mm



- Щипцы для ортодонтии и протезирования
- Pincas pour l'orthodontie et la prothèse
- Zangen für Kieferorthopädie und Prothetik
- Щипці для ортодонції та протезування
- Alicates para ortodoncia y prótesis
- كمامة لتقويم الأسنان بروشيبيس

CUTTER, UTILITY PLIERS & WIRE FORMING PLIERS



SI-2790
Weingart Pliers



SI-2795
Adhesive
Removing Pliers



SI-2791
Slim Weingart
Pliers

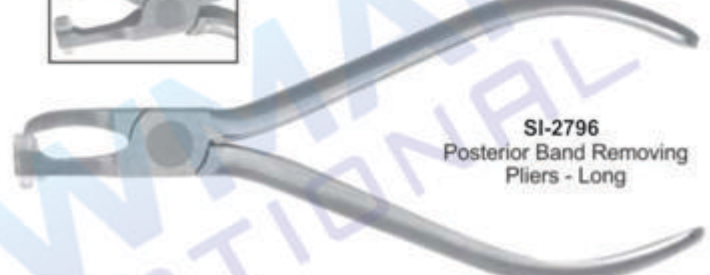

SI-2796
Posterior Band Removing
Pliers - Long



SI-2792
How Pliers
Straight

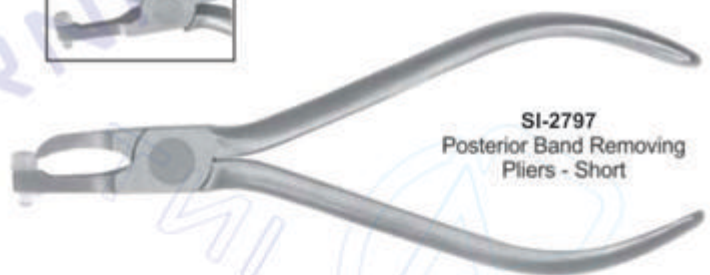

SI-2797
Posterior Band Removing
Pliers - Short



SI-2793
How Pliers Offset

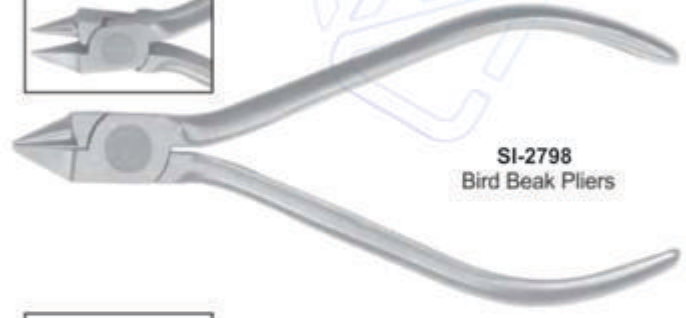

SI-2798
Bird Beak Pliers



SI-2794
Band seating Pliers



Replacement tip and
hex key included.

SI-2799
Omega Loop
Forming Pliers

- Щипцы для ортодонтии и протезирования
- Pincers pour l'orthodontie et la prothèse
- Zangen für Kieferorthopädie und Prothetik
- Щипці для ортодонції та протезування
- Alicates para ortodoncia y prótesis
- מכשירי לטיפול בלסתות ופרוטזיס

CUTTERS



SI-2800
Hard
Wire Cutter 15



SI-2804
Mini Pin &
Ligature Cutter



SI-2801
Distal End Cutter
Flush Cut



SI-2805
Hard Wire Cutter
Straight



SI-2802
Universal Cut & Hold
Distal End Cutter



SI-2806
Micro-Mini Pin &
Ligature Cutter



SI-2803
Pin & Ligature
Cutter



SI-2807
Cutter

PLIERS FOR ORTHODONTICS & PROSTHETICS

- Щипцы для ортодонтии и протезирования
- Pincas pour l'orthodontie et la prothèse
- Zangen für Kieferorthopädie und Prothetik
- Щипці для ортодонції та протезування
- Alicates para ortodoncia y prótesis
- کمانچه لتقویم الاسنان بروسلیکس



SI-2808
Three Jaw Pliers



SI-2812
Jarabak Pliers

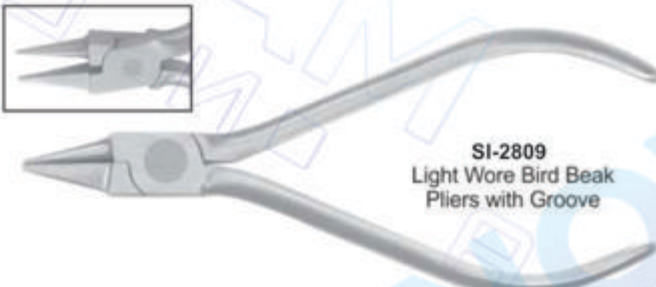

SI-2809
Light Wore Bird Beak
Pliers with Groove



SI-2813
Hollow Chop
Contouring Pliers



SI-2810
Tweed loop
Forming Pliers

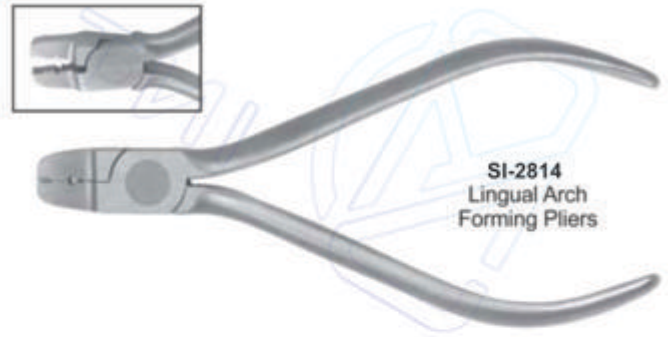

SI-2814
Lingual Arch
Forming Pliers

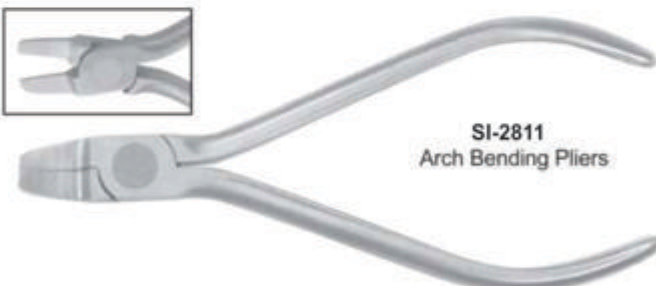

SI-2811
Arch Bending Pliers

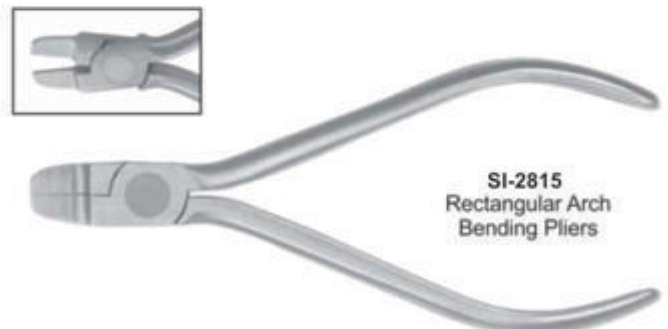

SI-2815
Rectangular Arch
Bending Pliers

ORTHODONTICS PLIERS STANDS

- Ортодонтия Щипцы Подставки
- Supports de pinces d'orthodontie
- Kieferorthopädie Zangenständer
- Ортодонтия Щипці Підставки
- KFO Zangen Ständer
- تقويم الأسنان كمشاشة تلف



SI-2816
Plier Stand
Stainless Steel.



SI-2817
Plier Stand
Stainless Steel.



SI-2818
Pliers Stand
Stainless Rod
(Aluminum Anodized)
Stainless Steel



SI-2819
Plier Stand
Stainless Steel.



SI-2820
Plier Stand
Stainless Steel.



SI-2821
Plier Stand
Plastic

Normal Anatomy – Dental Implants

Bone Level Normal
(No Bone Loss)

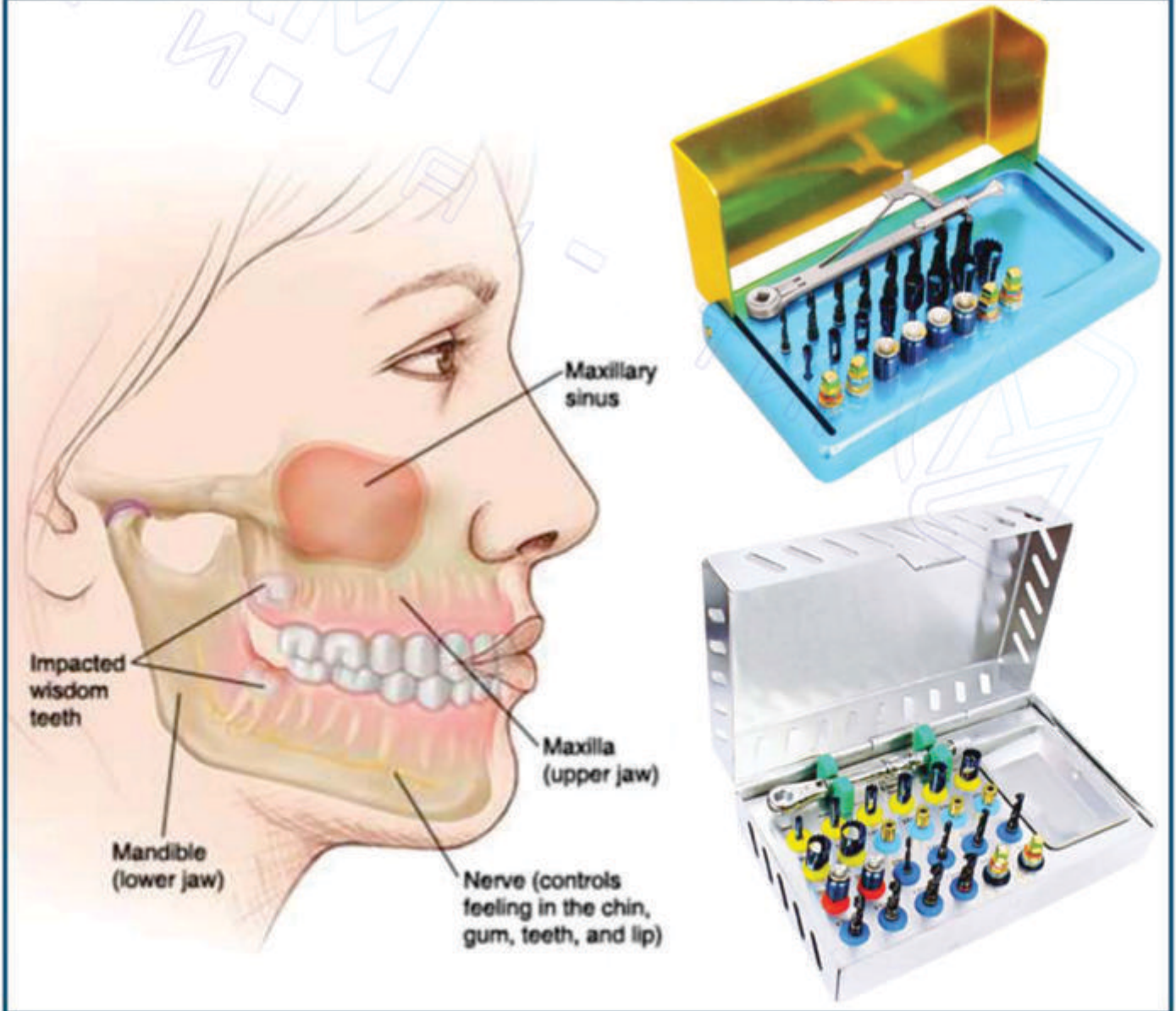
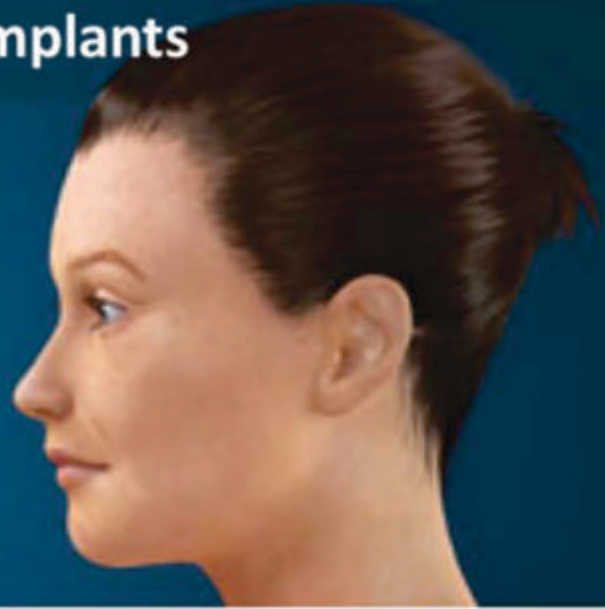
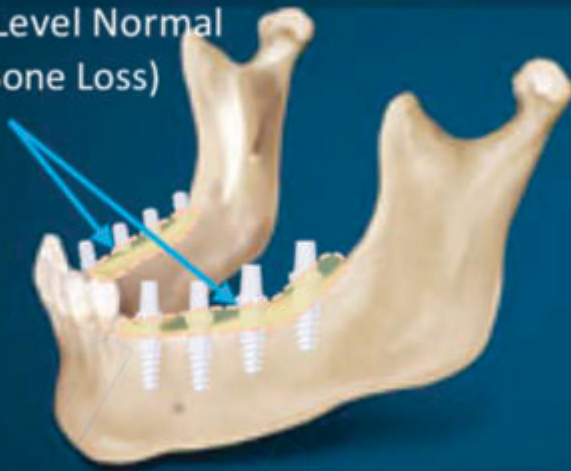

- Инструменты для имплантологии
 - Implantologie
 - Implantologie
- Инструменти для имплантології
 - Implantologia
 - زراعة الأسنان

IMPLANT GAGES



SI-2822
Multifunctional Meter
Length 90 mm,
different sizes,
8-10-11mm,
corrosion-resistant

SI-2823
Multifunctional Meter
Length 90 mm,
different sizes,
5-13-15-17 mm,
corrosion-resistant

SI-2824
Measuring Probe
Length 170 mm,
hand shape or flexible
(6-8-10-14-16 mm),
corrosion-resistant

SI-2825

SI-2826

SI-2827

SI-2828

IMPLANT GAGES



SI-2829

SI-2830

SI-2831

IMPLANTOLOGY

- Инструменты для имплантологии
- Implantologie
- Implantologie

- Инструменти для имплантології
- Implantoloia
- زراعة الأسنان



SI-2832
Ridge Mapping
Double Caliper



SI-2833
Bone Thickness Gauge
40mm, 180mm



SI-2834
Osteometer
Measuring Forceps For Jaw
Ridge Width measurement, scale
on both sides, rustfree, autoclaviv

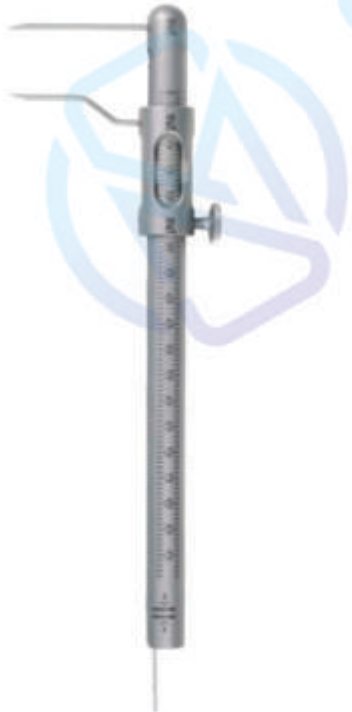

SI-2835
Micro Boley
Gauge Twisted



SI-2836
Micro Boley
Gauge Straight



SI-2837
Ortho Ruler / Cone Socket

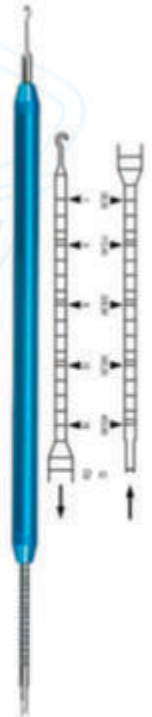

SI-2838
Dynamometer

- Инструменты для имплантологии
- Implantologie
- Implantologie
- Инструменти для імплантології
- Implantologia
- زراعة الأسنان

BLACK TITANIUM COLOUR COATED INSTRUMENTS



SI-2839
#1

SI-2840
#2

SI-2841
#3
Extra-Flex

SI-2842
#4
Extra-Flex

SI-2843
#5
Flexi-Thin

SI-2844
#6
Flexi-Thin

SI-2845
AB1
Boghosian

SI-2846
AB2
Boghosian

- Инструменты для имплантологии
- Implantologie
- Implantologie

- Инструменти для имплантології
- Implantoloia
- زراعة الأسنان

BLACK TITANIUM COLOUR COATED INSTRUMENTS



SI-2847
A
Cosmetic
Contouring

SI-2848
B
Cosmetic
Contouring

SI-2849
C
Cosmetic
Contouring

SI-2850
D
Cosmetic
Contouring

SI-2851
F
Cosmetic
Contouring

SI-2852
Marginal Ridge
& Embrasure
Shaping Instrument

SI-2853
Occlusal
Anatomy
Instrument

- Инструменты для имплантологии
 - Implantologie
 - Implantologie
- Инструменти для імплантології
 - Implantologia
 - زراعة الأسنان

BLACK TITANIUM COLOUR COATED INSTRUMENTS

BURNISHERS

FREEDMAN BURNISHERS

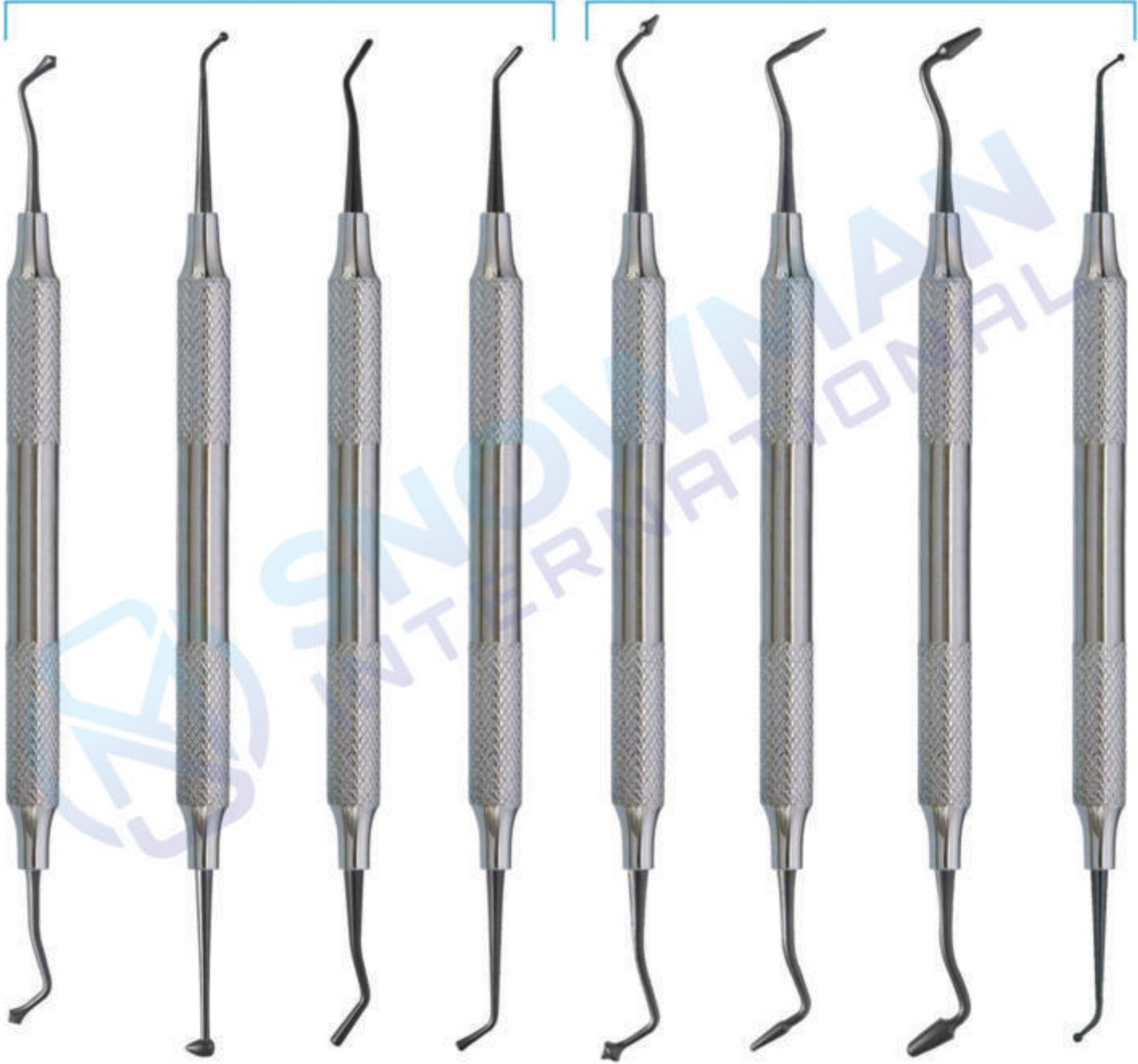

SI-2854
21B

SI-2855
27/29

SI-2856
2
Ladmore

SI-2857
3
Ladmore

SI-2858
Freedman
"Duckhead"

SI-2859
Freedman
Small Contact
Forming

SI-2860
Freedman
Large Contact
Forming

SI-2861
Small/
Medium Ball
Burnisher

IMPLANTOLOGY

- Инструменты для имплантологии
- Implantologie
- Implantologie

- Инструменти для імплантології
- Implantoloia
- زراعة الأسنان

SINUS LIFT INSTRUMENTS HOLLOW HANDLE 9.5MM LENGTH 170MM

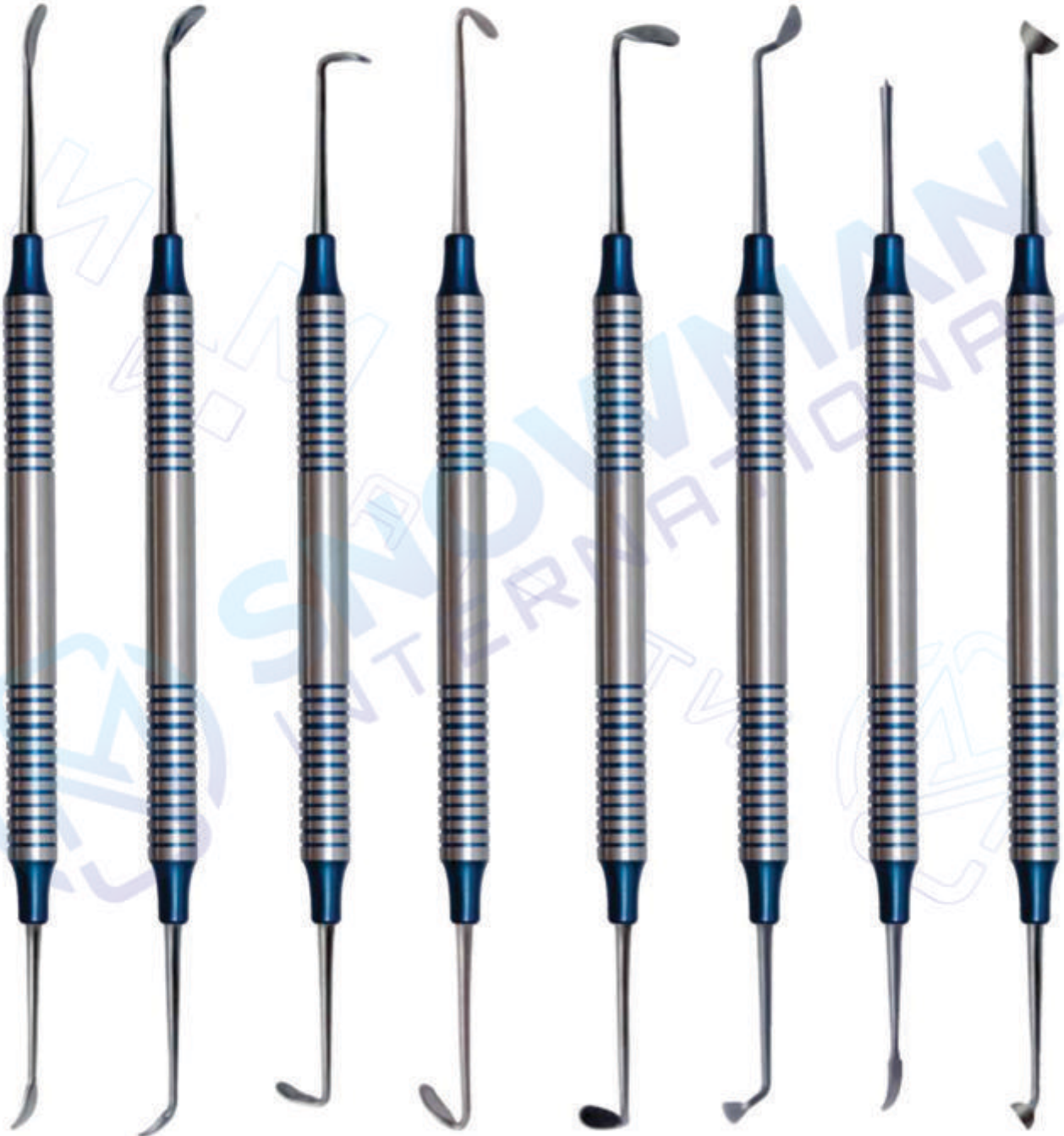

SI-2862
Sinuslift 1

SI-2863
Sinuslift 2

SI-2864
Sinuslift 3

SI-2865
Sinuslift 4

SI-2866
Sinuslift 5

SI-2867
Sinuslift 6

SI-2868
Membrane
3Positioning 1

SI-2869
Condenser 1

- Инструменты для имплантологии
- Implantologie
- Implantologie

- Инструменти для имплантології
- Implantologia
- زراعة الأسنان

Sinus Lift Instrument,
Flexible Sinus Lift instruments
reduce the risk of perforation of the
"Schneider's membrane"

Sinus Lift Elevator,
10 mm Straight grip
Length 175 mm, Sinus lift elevators, dull,
for gentle peeling and lifting the
Schneider membrane

Sinus lift instrument
10 mm Straight grip Length 180 mm,
Buser (B1, B2, B3) raspatories,
quality medical stainless steel,
corrosion-resistant



SI-2870
Fig. 1

SI-2871
Fig. 2

SI-2872
Fig. 3



SI-2873
Fig. 1

SI-2874
Fig. 2

SI-2875
Fig. 3



SI-2876
B01

SI-2877
B02

SI-2878
B03

- Инструменты для имплантологии
 - Implantologie
 - Implantologie
- Инструменти для имплантології
 - Implantoloia
 - زراعة الأسنان

Sinus lift instrument 10 mm Straight grip Sinus lift elevators, blunt or sharply curved (H01, H02, K03, K04, K78, K77)

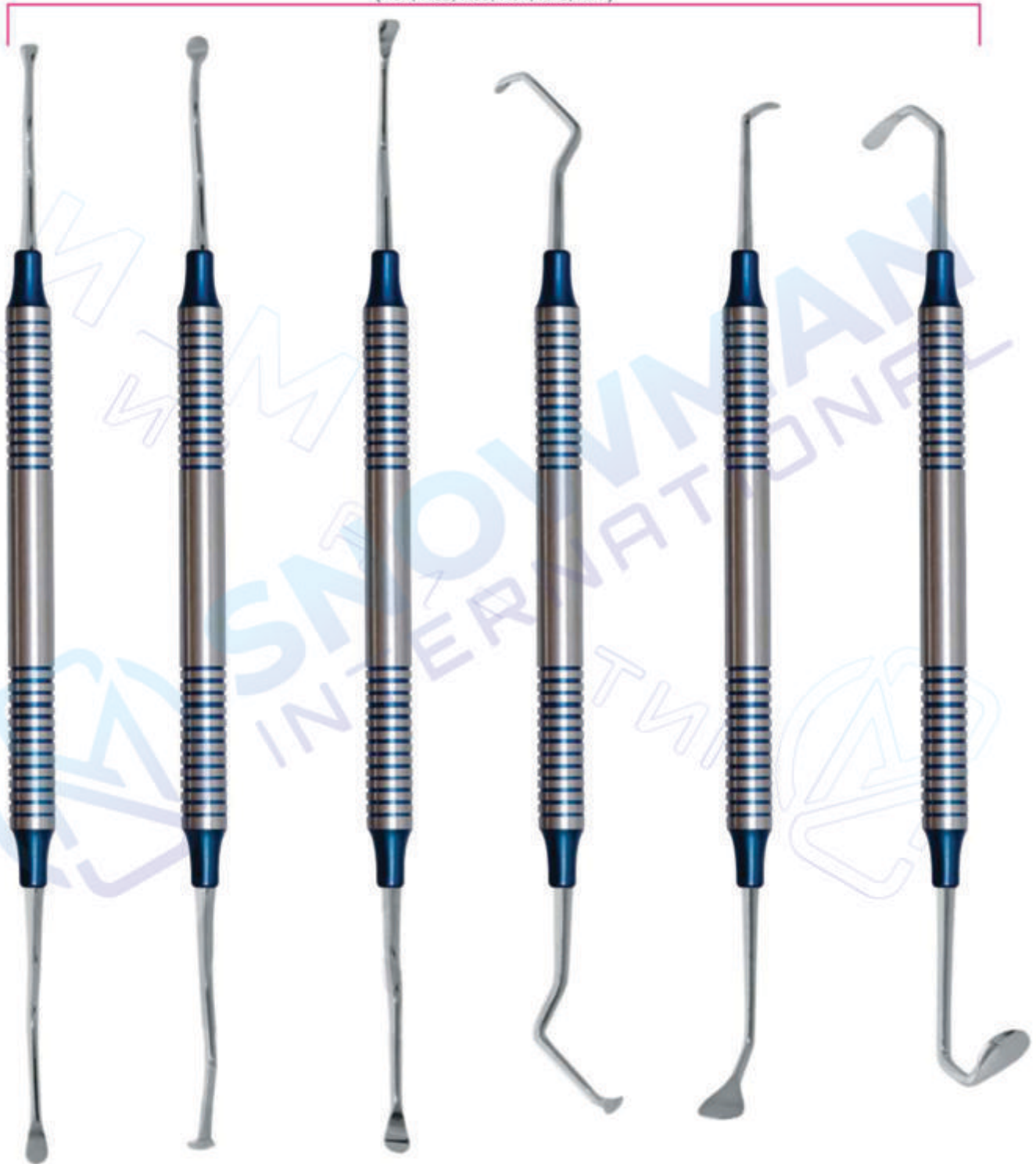

SI-2879
Sinus lift
instrument
H01

SI-2880
Sinus lift
instrument
H02

SI-2881
Sinus lift
instrument
K03

SI-2882
Sinus lift
instrument
K04

SI-2883
Sinus lift
instrument
K78

SI-2884
Sinus lift
instrument
K77

- Инструменты для имплантологии
 - Implantologie
 - Implantologie
- Инструменти для імплантології
 - Implantologia
 - زراعة الأسنان

Composite Filling Instruments Set of 6 Pcs



SI-2885



SI-2886



SI-2887



SI-2888



SI-2889



SI-2890

COMPOSITE INSTRUMENTS USE:

A composite (tooth colored) filling is used to repair a tooth that is affected by decay, cracks, fractures, etc. The decayed or affected portion of the tooth will be removed and then filled with a composite filling.

There are many types of filling materials available, each with their own advantages and disadvantages. You and your dentist can discuss the best options for restoring your teeth. Composite fillings, along with silver amalgam fillings, are the most widely used today. Because composite fillings are tooth colored, they can be closely matched to the color of existing teeth, and are more aesthetically suited for use in front teeth or the more visible areas of the teeth.

As with most dental restorations, composite fillings are not permanent and may someday have to be replaced. They are very durable, and will last many years, giving you a long lasting, beautiful smile.

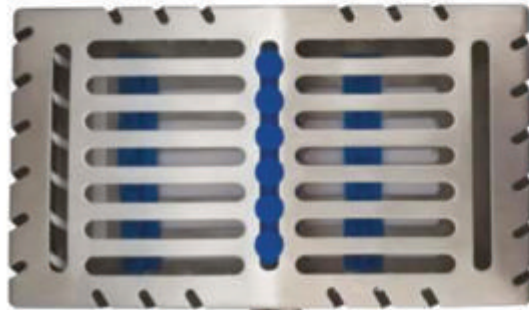

SI-2891

IMPLANTOLOGY

- Инструменты для имплантологии
- Implantologie
- Implantologie

- Инструменти для імплантології
- Implantoloia
- زراعة الأسنان

Set of 5 Composite Gold Tip Instruments
SI-2892

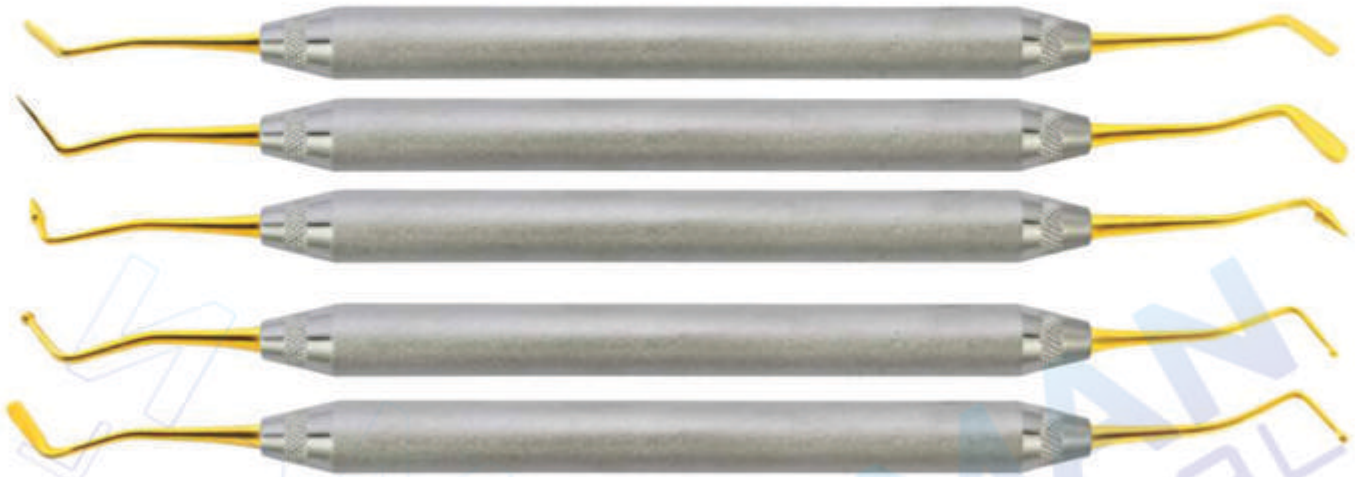

Set of 4 Composite Blue Tip Instruments
SI-2893



Set of 3 Composite Blue Tip Instruments
SI-2894



Set of 2 Composite Blue Tip Instruments
SI-2895



SI-2896 Periosteal Elevators Molt # 9

SI-2897 Endodontic explorer DG # 16

- Инструменты для имплантологии
- Implantologie
- Implantologie
- Инструменти для імплантології
- Implantologia
- زراعة الأسنان

VISTA TUNNELING INSTRUMENTS SET



SI-2898



SI-2899



SI-2900



SI-2901



SI-2902



SI-2903



SI-2904



IMPLANTOLOGY

- Инструменты для имплантологии
- Implantologie
- Implantologie

- Инструменти для имплантології
- Implantoloia
- زراعة الأسنان



SI-2905
used for elevation of sinus membrane



SI-2906
used for elevation of sinus membrane

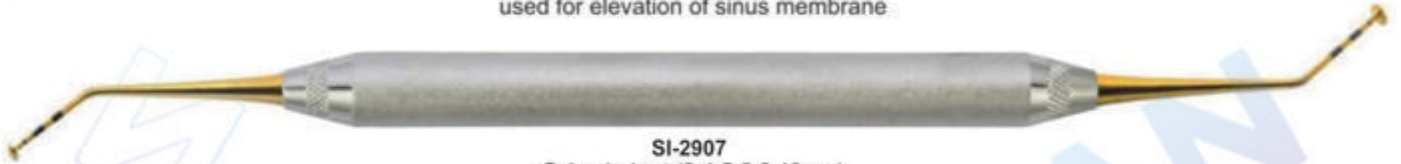

SI-2907
Cobra in / out (2-4-5-6-8-10mm)



SI-2908
Cobra 3.5mm

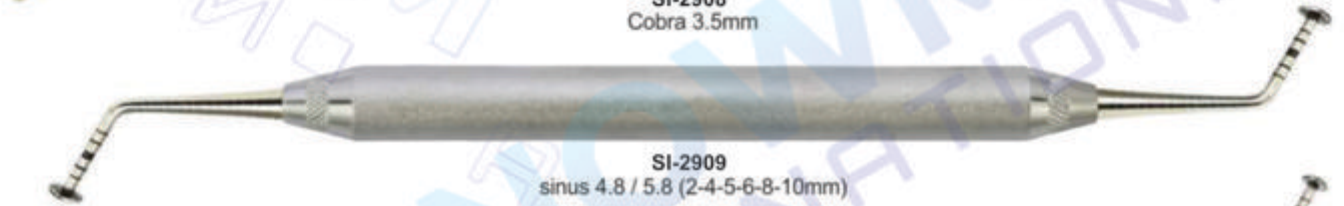

SI-2909
sinus 4.8 / 5.8 (2-4-5-6-8-10mm)

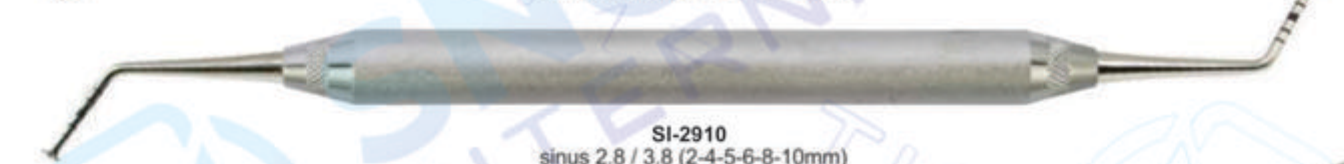

SI-2910
sinus 2.8 / 3.8 (2-4-5-6-8-10mm)



SI-2911
Bone Graft 3.8SP / 2.8mm (2-4-5-6-8-10mm)



SI-2912
Cobra in / out (2-4-5-6-8-10mm)



SI-2913
Cobra 3.5mm



SI-2914
Gold Color Set Dental Oral Implantology Sinus Set of 10 Pcs with cassette

- Инструменты для имплантологии
- Implantologie
- Implantologie
- Инструменти для імплантології
- Implantologia
- زراعة الأسنان



SI-2915
Sinus Lift elevator 1

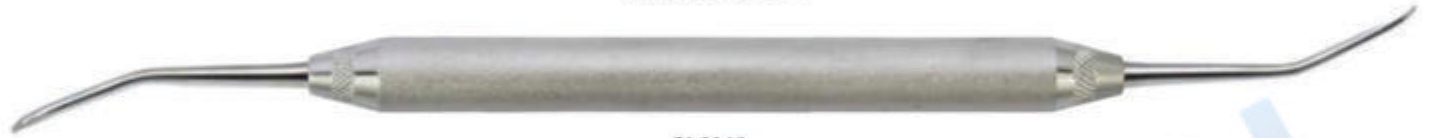

SI-2916
Sinus Lift elevator 2



SI-2917
Sinus Lift elevator 3



SI-2918
Sinus Lift elevator 4



SI-2919
Sinus Lift elevator 5



SI-2920
Sinus Lift elevator 6



SI-2921
Sinus Lift Elevators Set of 7 Pcs
with cassette

- Инструменты для имплантологии
 - Implantologie
 - Implantologia
- Инструменти для имплантології
 - Implantoloia
 - زراعة الأسنان

Sinus Left Elevator Set of 10 Pcs

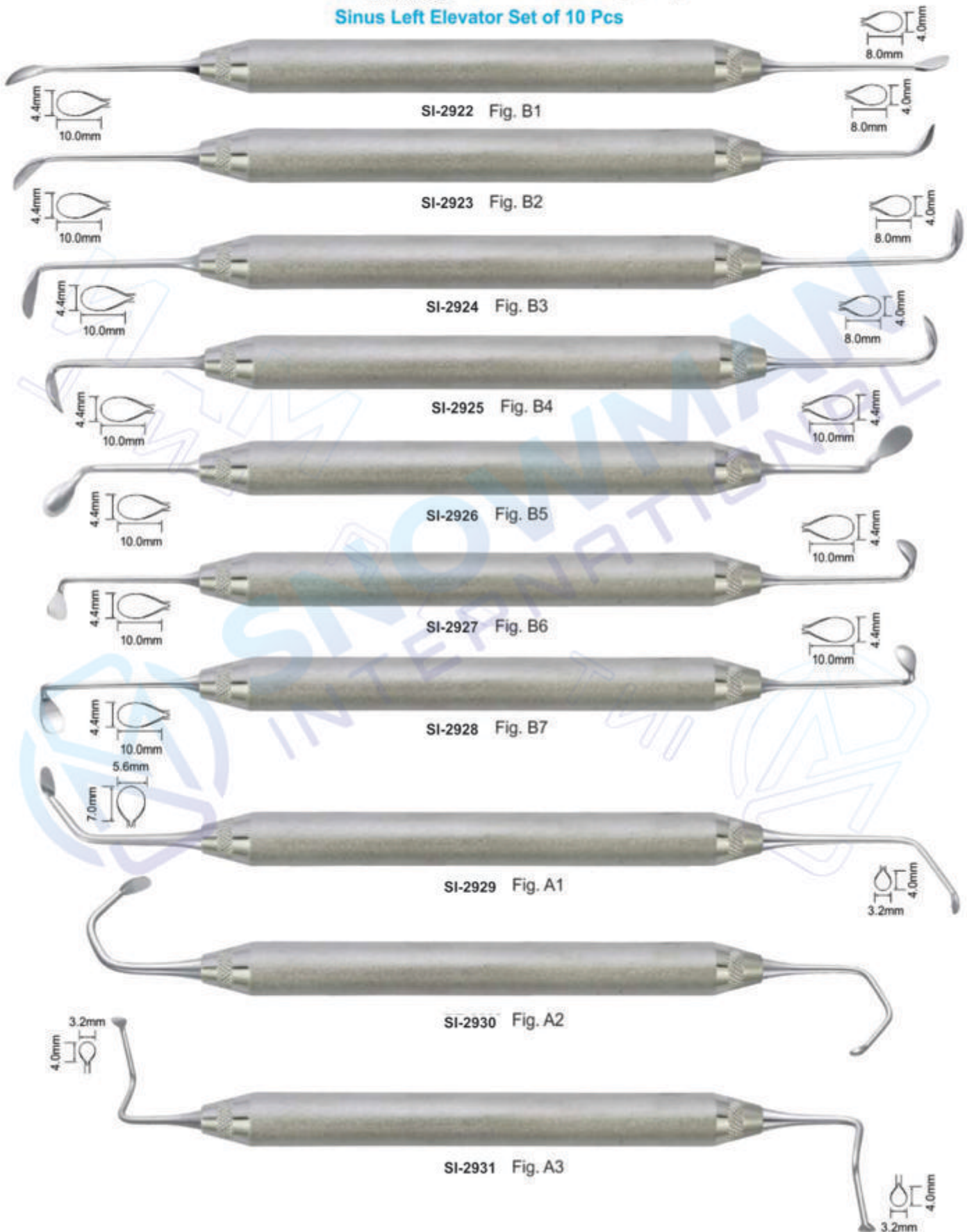

- Инструменты для имплантологии
 - Implantologie
 - Implantologie
- Инструменти для імплантології
 - Implantoloia
 - زراعة الأسنان

Blue Titanium Coated Bone Grafting Instruments



SI-2932

Bone Graft 1.0 / 1.7 mm Titanium 8, 11, 13, 15, 18 mm



SI-2933

Bone Graft 1.0 / 2.0 mm Titanium 8, 11, 13, 15, 18 mm



SI-2934

Bone Graft 2.4 / 2.7 mm Titanium 8, 11, 13, 15, 18 mm

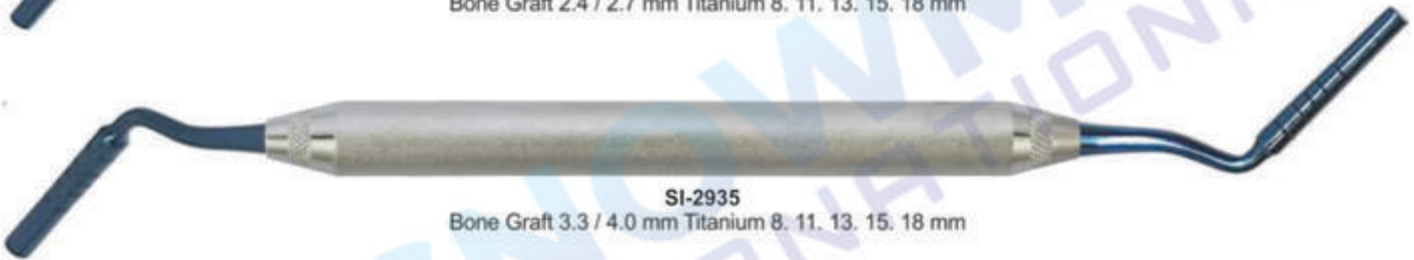

SI-2935

Bone Graft 3.3 / 4.0 mm Titanium 8, 11, 13, 15, 18 mm



SI-2936

Bone Graft 3.3 / 4.0 mm Titanium Coated Tips



SI-2937

Bone Graft / Carrier Titanium 8, 11, 13, 15, 18 mm



SI-2938

Blue Titanium Coated Bone Grafting Instruments Set of 7 Pcs with cassette

- Инструменты для имплантологии
- Implantologie
- Implantologie

- Инструменти для имплантології
- Implantoloia
- زراعة الأسنان

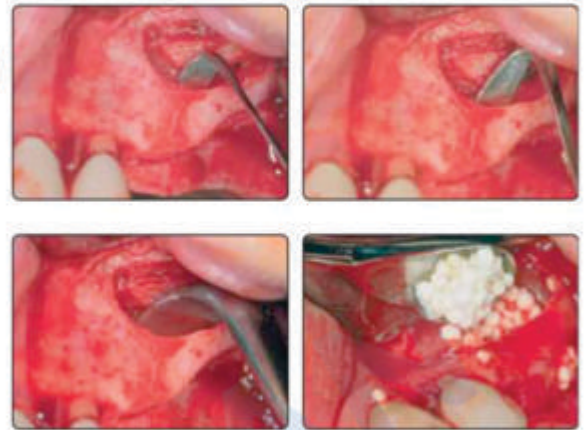
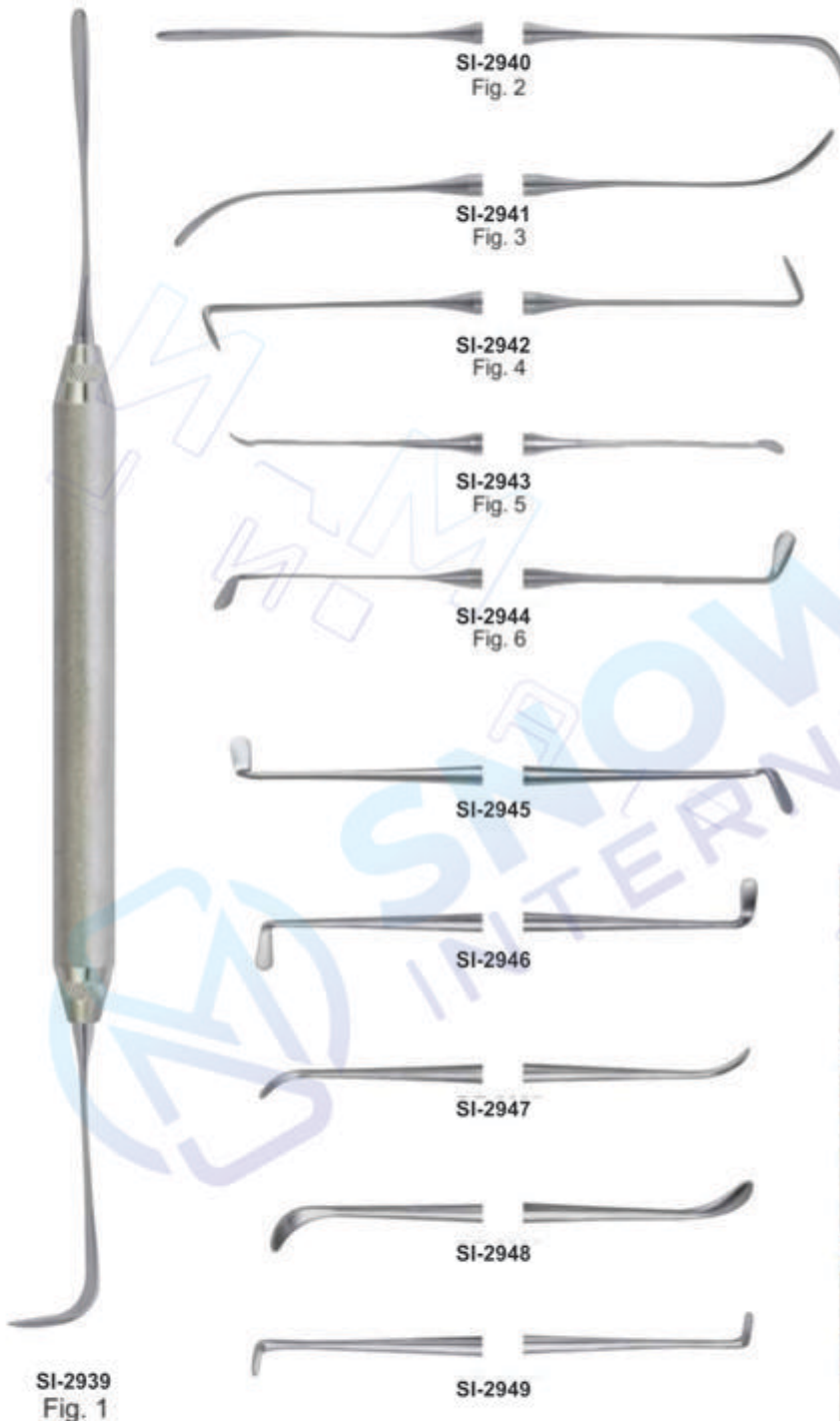

Flexible Sinus-Lift Curettes – for an optimum sensitivity during the direct lift procedure
 The perforation of the Schneiderian membrane is a complication that often occurs during a maxillary sinus floor augmentation procedure. The Sinus-Lift Instruments increase the sensitivity by blunt and flexible working tips with "Swing-Effect". Because of their special shapes and the characteristic of the stainless steel between the handle and the active part, light pressure is cushioned and gives the operator a direct and sensitive response. At the same time the risk to perforate the Schneiderian membrane is reduced to a minimum. Already at the development the focus was a practicable handling. Because of varying angulations and shapes of the active parts also in difficult areas they are easy to navigate also in difficult areas. The line of curettes consists of six different figures for every situation. They are complemented by spoon and condenser to place the bone graft.

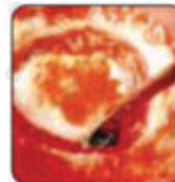

The "Schneider's Membrane" of the sinus can be detached with curette by 1-2mm along the total cortical bone.



Curette is particularly useful in the lower part for detaching the membrane further. The same goes for the caudal area, especially when the membrane is 4-5 mm above the base of the maxillary sinus and the maxillary sinus is built up with granular material.



Curette makes it possible to lift the membrane further in mesial region. One working tip is especially designed for the right maxillary sinus and the other for the left maxillary sinus.



With curette the sinus membrane is further elevated in the upper and posterior part of the maxillary sinus wall.



With curette the sinus membrane is further detached over a broad area in the inner region, especially along the roof of the palate.

SI-2939
Fig. 1

SI-2949

SI-2940
Fig. 2

SI-2941
Fig. 3

SI-2942
Fig. 4

SI-2943
Fig. 5

SI-2944
Fig. 6

SI-2945

SI-2946

SI-2947

SI-2948

- Инструменты для имплантологии
- Implantologie
- Implantologie

- Инструменти для імплантології
- Implantologia
- زراعة الأسنان

IMPLANT SINUS LIFT INSTRUMENTS HOLLOW HANDLE 9.5MM LENGTH 170MM



SI-2950
Acute 6577

SI-2951
Sinus 1

SI-2952
Sinus 2

SI-2953
Sinus
Obtuse 6...

SI-2954
Sinus 4

SI-2955
Sinus 5

SI-2956
Sinus 6

SI-2957
Sinus 7



9 Pcs of Set
SI-2958

SINUS LIFT INSTRUMENTS HOLLOW HANDLE 9.5MM LENGTH 170MM



SI-2960
Sinuslift 2

SI-2961
Sinuslift 3

SI-2962
Sinuslift 4

SI-2963
Sinusl

SI-2964
Sinusl

SI-2965
Membrane
3Positioning 1

SI-2966
Condenser 1

SI-2959
Sinuslift 1



9 Pcs of Set
SI-2967

IMPLANTOLOGY

- Инструменты для имплантологии
- Implantologie
- Implantologie

- Инструменти для имплантології
- Implantoloia
- زراعة الأسنان

IMPLANT SINUS LIFT INSTRUMENTS PERIODONTAL SURGERY SURGICAL CHISELS KRAMER NEVINS SINUS LIFT

SURGICAL CHISELS



SI-2968
TG



SI-2969 SOLT3/4



SI-2970 TGO



SI-2971 OCH3



SI-2972 OCH4



SI-2973 FEDI1



SI-2974 FEDI2



SI-2975 FEDI3



3.5mm

SI-2976 13K/TG

3mm



3.5mm

SI-2977
13K/TG Titanium

3mm



3.5mm

SI-2978 13K/TG

4.5mm

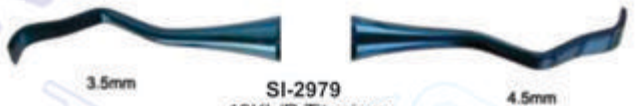

3.5mm

SI-2979
13KL/R Titanium

4.5mm



4mm

SI-2980 13KL 4/6mm
Titanium Available

6mm



SI-2981
Cassette For Instruments

- Инструменты для имплантологии
 - Implantologie
 - Implantologie
- Инструменти для імплантології
 - Implantologia
 - زراعة الأسنان

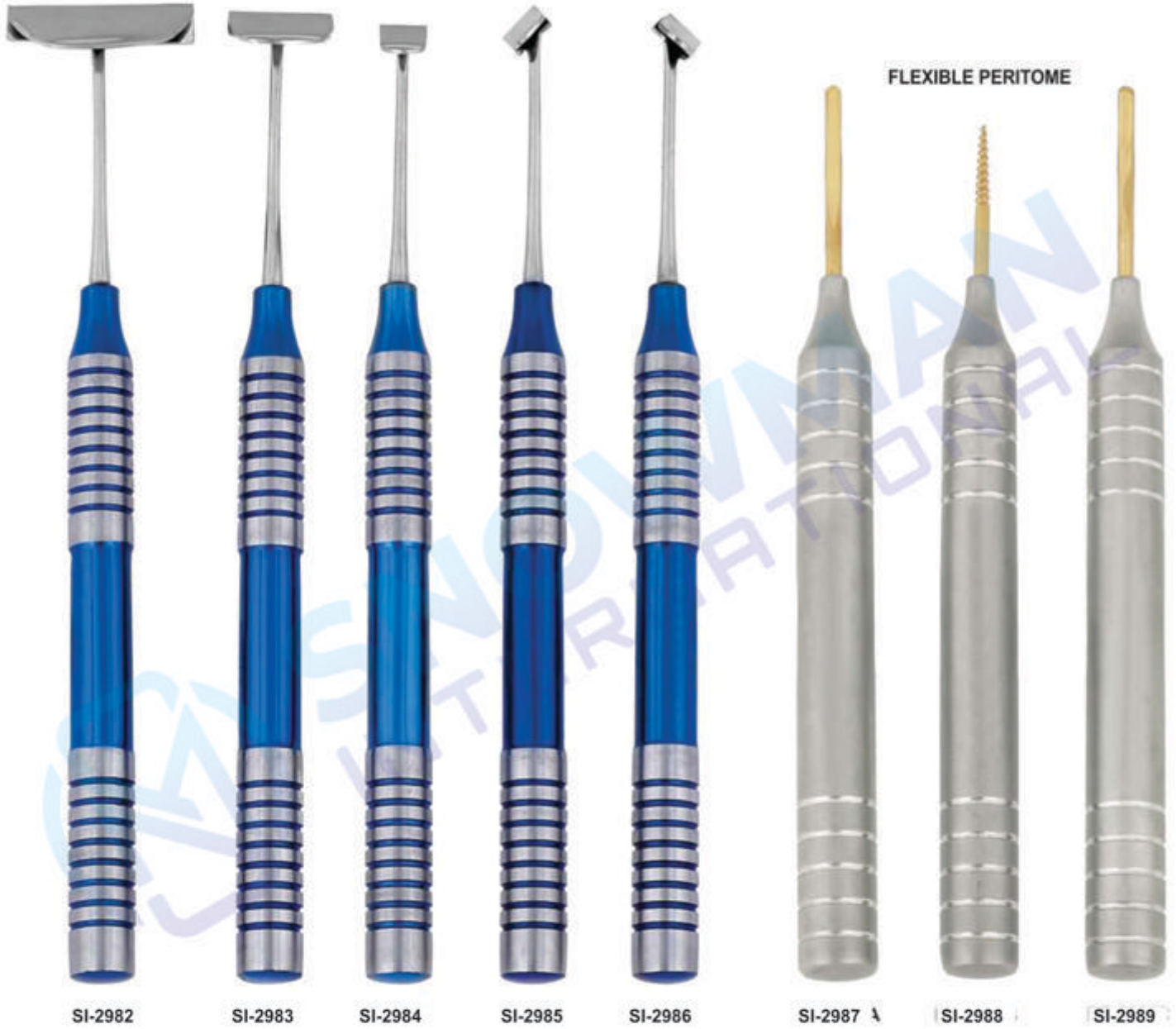

SI-2982

SI-2983

SI-2984

SI-2985

SI-2986

SI-2987

SI-2988

SI-2989

Soft Brushing Kit Set of 6 Pcs



IMPLANTOLOGY

- Инструменты для имплантологии
- Implantologie
- Implantologie

- Инструменти для имплантології
- Implantoloia
- زراعة الأسنان

SINUS ELEVATOR & MEMBRANE LIFT TIPS



SI-2990
Membrane Detach Elevator



SI-2991
Membrane Elevator



SI-2992
Membrane Elevator

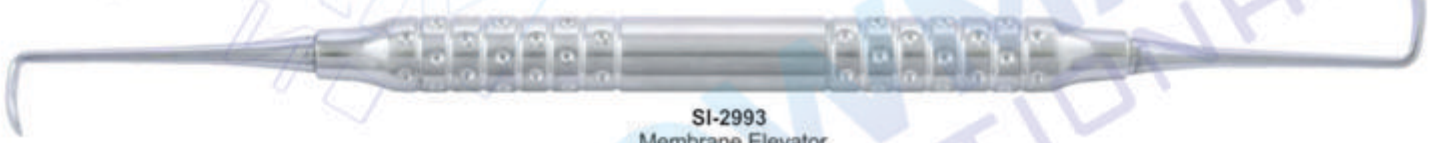

SI-2993
Membrane Elevator



SI-2994
Membrane Elevator



SI-2995
Bone Graft Packer



SI-2996 A Pt2 Titanium
A/V Regular



SI-2996 B Pt1 Titanium
A/V Regular



SI-2996 C Pt3 Titanium Angel S/E



SI-2996 D Pt4 Titanium STR S/E



SI-2996 E Pt5 Titanium TG CVD S/E



SI-2997
Sinus Left Elevator & Membrane Lift Tips 3
set of 7 Pcs

- Инструменты для имплантологии
- Implantologie
- Implantologie
- Инструменти для имплантології
- Implantologia
- زراعة الأسنان

MIXING SPATULA WITH SHOVEL



SI-2998
Bone Carrier
Titanium



SI-2999
Raspator, Prichard
Length 180 mm,
10 mm hollow handle,
double-ended
10.5 mm | 4.5 mm,



SI-3000
Raspator, Prichard
Length 180 mm,
10 mm hollow handle,
double ended



SI-3001
Raspator, Prichard
Length 180 mm,
10 mm hollow handle,
double-ended
10.5 mm | 4.5 mm,



SI-3002
Mixing Spatula
with shovel
17cm



SI-3003
Mixing Spatula
with shovel
18.5cm



SI-3004
Graft Material Spoon
Concave Tip For
Larger Grafts

IMPLANTOLOGY

- Инструменты для имплантологии
 - Implantologie
 - Implantologie
- Инструменти для имплантології
 - Implantoloia
 - زراعة الأسنان

BONE GRAFTING INSTRUMENTS COMPACTOR /TAMPERS

Product offering includes instruments for harvesting, mixing and compacting bone Provides clinicians with the proper instrumentation for bone grafting procedures Weighted bone basin Prevents tipping and spilling of bone and other materials during mixing



SI-3005
Graft Packer, Concave Tips DE 4/6mm



SI-3006
Bone Spoon/ Packer DE 3mm



SI-3007
Blade and pusher Length 180 mm, for straight or angled, blade: 15 x 5 mm, pusher: 4 mm diameter Straight



SI-3008
Blade and pusher Length 180 mm, for straight or angled, blade: 15 x 5 mm, pusher: 4 mm diameter angular



SI-3009
Spoon and pusher Length 180 mm, for angled spoon: 10 x 5 mm, pusher: diameter 3 mm



SI-3010
Graft Packer, Smooth Tips DE 5/8mm



SI-3011
Graft Packer, Serrated Tips DE 3/4mm



SI-3012
Graft Packer, Serrated Tips DE 6/8mm



SI-3013
Titanium graft packer/placement site depth gauge 3.3mm & 4.0mm Diameter tips Marked at 8, 11, 13, 15 & 18mm



SI-3014
Tamper Length 170 mm, for bone material, double-ended, diameter 3.2 mm (2-4-6-8-10) and diameter 2.5mm (2-4-6-8-10)

- Инструменты для имплантологии
 - Implantologie
 - Implantologie
- Инструменти для імплантології
 - Implantoloia
 - زراعة الأسنان

SPOON AND PUSHER (TRINOVO)

Trinovo handle, different workers, for bone material, high-grade medical stainless steel, corrosion-resistant



IMPLANTOLOGY

- Инструменты для имплантологии
- Implantologie
- Implantologia

- Инструменти для імплантології
- Implantoloia
- زراعة الأسنان

Hollow Handle 10mm Length 170mm

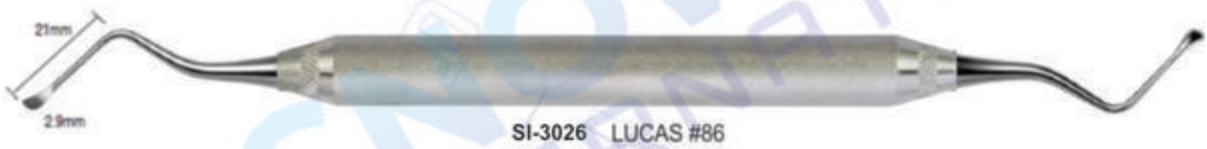

- Инструменты для имплантологии
 - Implantologie
 - Implantologie
- Инструменти для имплантології
 - Implantoloia
 - زراعة الأسنان

TISSUE MEMBRANE FORCEPS



SI-3031
Tissue Graft Forcep
Serrated Teeth



SI-3032
Self Locking
Grooved



SI-3033
Tissue Graft Forcep
Serrated Teeth



SI-3034
Titanium
Locking Plier



SI-3035
TC Gripper Carbide
Tipped Tissue Forceps
Serrated Carbide Tips
14.5cm



SI-3036
Adson Carbide
Tipped Tissue Forceps
Serrated Carbide Tips
12cm



SI-3037
Micor Adson 1x2
Tissue Forcep 12.1cm
1x2 Teeth - 0.5mm Tips



SI-3038
Adson 7x7
Tissue Forceps
7x7 Teeth 12cm



SI-3039
Adson 7x7 Curved
Tissue Forceps
7x7 Teeth 12cm



SI-3040
Suture Pliers
Suture Forceps with
1.6mm Ring Tip



SI-3041
Debaquey Atraumatic
Tissue Forceps Straight
Serrated Teeth
16cm



SI-3042
Debaquey Atraumatic
Tissue Forceps Curved
Serrated Teeth
16cm

- Инструменты для имплантологии
- Implantologie
- Implantologie

- Инструменти для имплантології
- Implantoloia
- زراعة الأسنان

TISSUE MEMBRANE FORCEPS



SI-3043
Russian Long
Tissue Forceps
Serrated Tip
20cm



SI-3044
Russian
Tissue Forceps
Serrated Tip
15cm



SI-3045
Tissue Punch Forceps
To Remove Tissue
After Using Punch



SI-3046
13.5 cm
narrow



SI-3047
10.5 cm

Membrane tweezers KUEHNE



SI-3048
13.5 cm
wide



SI-3049
Pin-Tweezers
with or without lock,
length 15 cm,
with lock



SI-3050
without lock



SI-3051
Haltepinzette with lock
15,5 cm, for pins, towards
the tips, etc



SI-3052
Carry Forceps
15cm



SI-3053
Carry Forceps
15cm



SI-3054
Carry Forceps
15cm

- Инструменты для имплантологии
 - Implantologie
 - Implantologie
- Инструменти для імплантології
 - Implantoloia
 - زراعة الأسنان

OSTEOTOME CONVEXES / CONCAVE / CONIQUES

CONVEXES



SI-3055
SET OF 5 PIECES

CONCAVES



SI-3056
SET OF 5 PIECES

CONIQUES

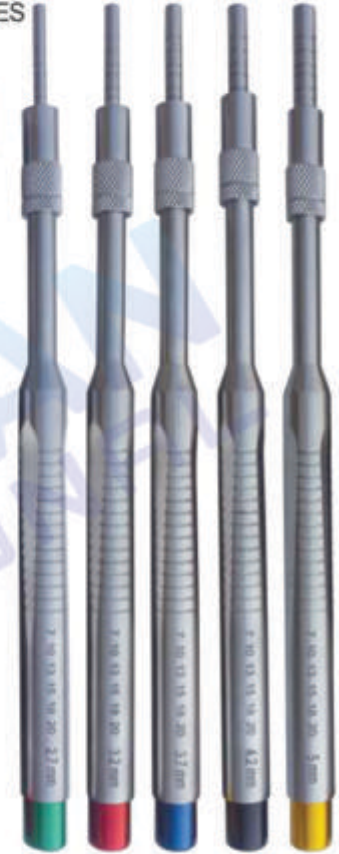

SI-3057
SET OF 5 PIECES

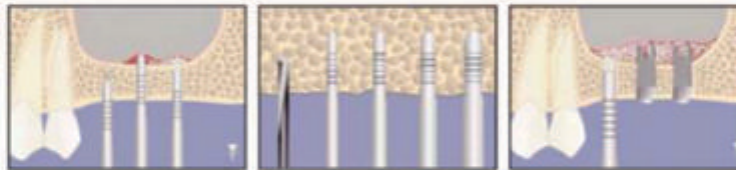

	CONVEXES STRAIGHT	SI-3058	2,7 Ømm	3,2 Ømm	3,7 Ømm	4,2 Ømm	5 Ømm
	CONCAVES STRAIGHT	SI-3059	2,7 Ømm	3,2 Ømm	3,7 Ømm	4,2 Ømm	5 Ømm
	CONIQUES STRAIGHT	SI-3060	2,7 Ømm	3,2 Ømm	3,7 Ømm	4,2 Ømm	5 Ømm

IMPLANTOLOGY

- Инструменты для имплантологии
- Implantologie
- Implantologie

- Инструменти для имплантології
- Implantoloia
- زراعة الأسنان

OSTEOTOME CONVEXES / CONCAVE / CONIQUES

CONVEXES



SI-3061
SET OF 5 PIECES

CONCAVES



SI-3062
SET OF 5 PIECES

CONIQUES



SI-3063
SET OF 5 PIECES

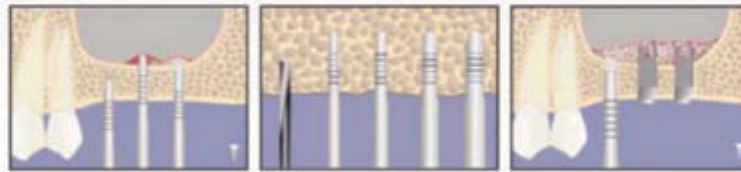

	CONVEXES CURVED	SI-3064	2,7 Ømm	3,2 Ømm	3,7 Ømm	4,2 Ømm	5 Ømm
	CONCAVES CURVED	SI-3065	2,7 Ømm	3,2 Ømm	3,7 Ømm	4,2 Ømm	5 Ømm
	CONIQUES CURVED	SI-3066	2,7 Ømm	3,2 Ømm	3,7 Ømm	4,2 Ømm	5 Ømm

- Инструменты для имплантологии
- Implantologie
- Implantologie

- Инструменти для імплантології
- Implantoloia
- زراعة الأسنان

BONE SCRAPER STRAIGHT & CURVED



SI-3067
Bone Scraper
Straight

SI-3068
Bone Scraper
Curved

TISSUE PUNCH STRAIGHT & CURVED



Tissue Punch
Straight

Tissue Punch
Curved

Ø4.0 Ø5.0 Ø6.0 Ø7.0



SI-3081
Tissue Punch with pin
Set of Four Pieces



SI-3082
Tissue Punch
Set of Five Pieces



SI-3083
Tissue Punch
Set of Five Pieces

IMPLANTOLOGY

- Инструменты для имплантологии
- Implantologie
- Implantologie
- Instrumenti для имплантології
- Implantoloia
- زراعة الأسنان

BONE MILL BONE WELL

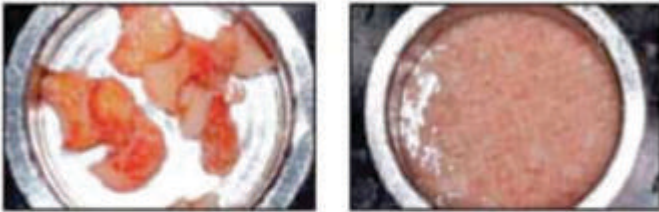

- Инструменты для имплантологии
 - Implantologie
 - Implantologie
- Инструменти для імплантології
 - Implantologia
 - زراعة الأسنان

TREPHINE

Burs with depth markings are suited for precise and simple transplantation of cylindrical bone grafts as well as for all other bone-extraction tasks.



SI-3099
Trephine Drill
Set of Eight Pieces



SI-3100
Trephine Drill
Set of Eight Pieces

BONE INJECTORS, COLLECTORS & SUCTION TUBE

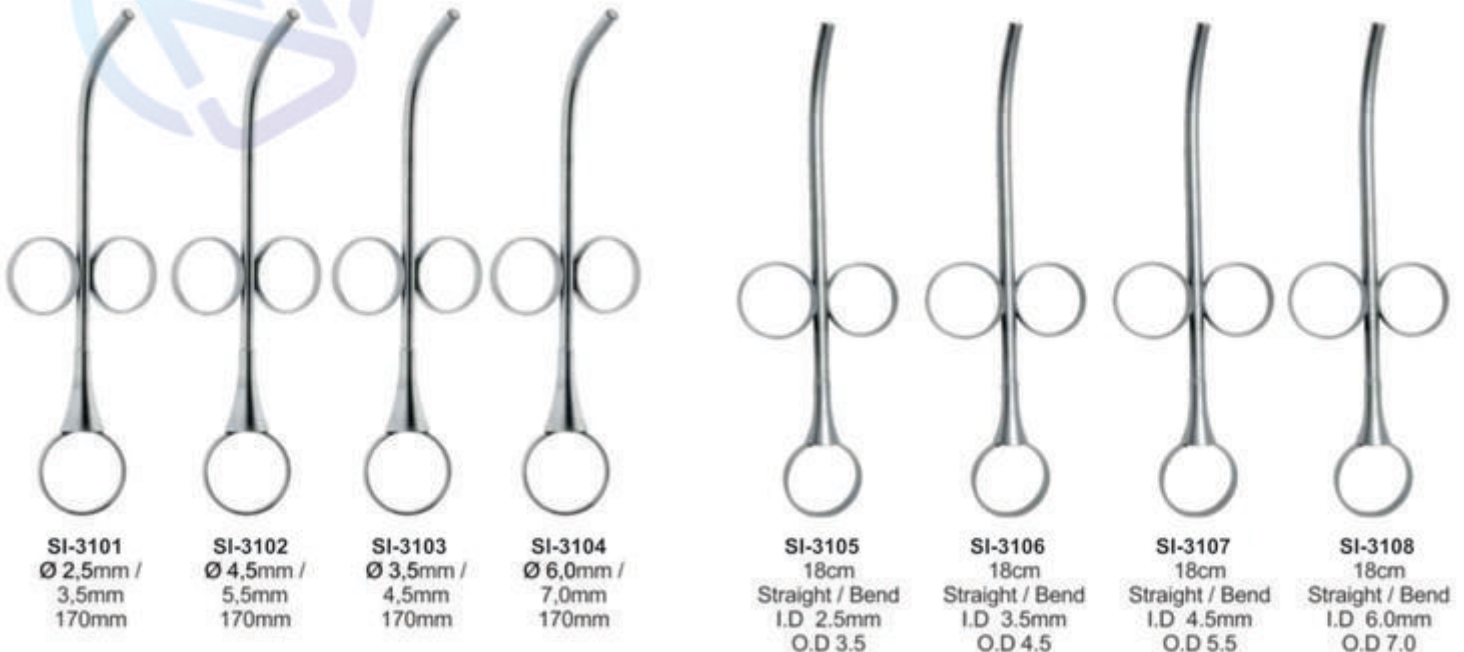

IMPLANTOLOGY

- Инструменты для имплантологии
- Implantologie
- Implantologie

- Инструменти для имплантології
- Implantoloia
- زراعة الأسنان

BONE EXPANDER SCREW & SURGICAL KITS



Ø2.0mm Ø2.5mm Ø2.8mm

SI-3109 Short Implant Drills



Ø3.2mm Ø3.65mm Ø4.2mm Ø5.2mm

SI-3110 Long Implant Drills



SI-3111

Bone Universal Kit

Drill: 2mm, 2.8mm, 3.2mm, 3.65mm, 4.2mm, 4.5mm, 4.8mm, 5.2mm
 Trephines Bit: 3.0mm, 4.0mm, 5.0mm, 6.0mm, 7.0mm, 8.0mm, 9.0mm, 10mm.
 Driver: 2.5mm, 2.5mm Hand Pcs, 1.25mm, 1.25mm Hand Pcs
 Short Driver 2.5mm, Long Driver 2.5mm
 1.25mm, Short Hex Driver Hand Pcs
 1.25mm, Long Hex Driver Hand Pcs, Torque Wrench 4.0mm



SI-3112

Bone Expander Kit

Expander: 2.6mm, 3.0mm, 3.4mm, 3.8mm, 4.3mm
 Ratchet Driver, Parallel Pin
 Pilot Drill, Drill 1.4mm, Drill Driver 4mm
 Hand Driver 4mm, Ratchet 4.0mm



SI-3113

Bone Universal Kit

Drill: 2mm, 2.8mm, 3.2mm, 3.65mm, 4.2mm, 4.5mm, 4.8mm, 5.2mm
 Trephines Bit: 3.0mm, 4.0mm, 5.0mm, 6.0mm, 7.0mm, 8.0mm, 9.0mm, 10mm.

Bone Compression:

2mm, 3.3mm, 2.8mm, 4.2mm, 3mm, 3.5mm
 Driver: 2.5mm, 2.5mm Hand Pcs
 1.25mm, 1.25mm Hand Pcs
 Short Driver 2.5mm
 Long Driver 2.5mm
 1.25mm, Short Hex Driver Hand Pcs
 1.25mm, Long Hex Driver Hand Pcs
 Torque Wrench 6.35mm 1 Pcs



SI-3114

Bone Expander Kit

Conical Drills: 20 Pcs
 Tissue Punches: 3.0mm, 3.50mm, 4.0mm, 4.5mm, 5.0mm, 6.0mm, 6.50mm
 Bone Expander: 1.6/3.8mm, 1.9/3.0mm, 2.1/3.6mm, 2.6/3.8mm, 2.9/4.3mm
 Drill Adapter: 1 Pcs
 1.25mm, 2.50mm Hex Driver Hand Pcs

Pilot Drill:

1.6mm
 Drill Bit: 1.4mm, 1.6mm, 1.8mm, 2.0mm, 2.2mm
 Ratchet Driver: 4mm/6.35, 1.25/2.50
 Rimer: 3.2/4.7mm, 3.7/4.7mm
 Parallel Pin: 4.5mm, 2.5mm
 Double step Drill: 2.4/2.8mm
 Depth Gauge: 1 Pcs
 Torque Wrench 6.35mm Universal: 1 Pcs

- Инструменты для имплантологии
 - Implantologie
 - Implantologie
- Инструменти для імплантології
 - Implantologia
 - زراعة الأسنان

KEYS FOR IMPLANT SCREW



SI-3115

SI-3116

SI-3117

SI-3118

TORQUE WRENCH & RATCHET



SI-3119 Star Torque Wrench 6.35mm Universal

SI-3125 Star Torque Wrench 6.35mm Universal

DE-2399 Star Ratchet Wrench 6.35mm Universal

SI-3120 Round Torque Wrench 4.0mm Universal

SI-3126 Star Torque Wrench 6.35mm Universal

DE-2400 Star Ratchet Wrench 4.0mm Universal

SI-3121 Hex Driver With 4.0mm Driver

SI-3127 Star Torque Wrench 6.35mm Universal

DE-2401 Round Ratchet Wrench 4.0mm Universal

SI-3122 Star Torque Wrench 6.35mm Universal

SI-3128 Star Torque Wrench 6.35mm Universal

DE-2402 Round Ratchet Wrench 3.35mm Universal

SI-3123 Hex Torque Wrench 4.00mm Universal

SI-3129 Star Ratchet Wrench 6.35mm Universal

DE-2403 Star Ratchet Wrench 4.0mm Universal

SI-3124 Star Torque Wrench 6.35mm Universal

SI-3130 Star Ratchet Wrench 6.35mm Universal

DE-2404 Star Ratchet Wrench 6.35mm Universal

IMPLANTOLOGY

- Инструменты для имплантологии
- Implantologie
- Implantologie

- Инструменти для імплантології
- Implantologia
- زراعة الأسنان



SI-3131
Suction Cannula Kit
with 3 Needles



Suction Pipe



Suction Needle
1mm



Suction Needle
1.5mm



Suction Needle
2mm



2cm

2.7cm

With Filter

SI-3132
17.5cm

SI-3133
18cm

SI-3134
coarse
Ø 5mm



SI-3135
fine
Ø 9mm

Suction tubes to collect
the extracted
bone material
180mm



1.5mm

SI-3136
Suction
Tubes
180mm



3mm

SI-3137
Suction
Tubes
180mm



5mm

SI-3138
Suction
Tubes
180mm



SI-3139
Fig. 6FR
Frazier
15 cm - Ø 2 mm

- SI-3140**
Ø 3 mm
length 180mm
- SI-3141**
Ø 4 mm
length 180mm
- SI-3142**
Ø 5 mm
length 180mm

IMPRESSION TRAYS

- Оттисные ложки
- Porte-empreinte
- Abdrucklöffel
- Відбиткові ложки
- Cubetas para impresiones
- صواني الانطباع

PERFORATED WITH RIM LOCK

Set of 06 Pcs

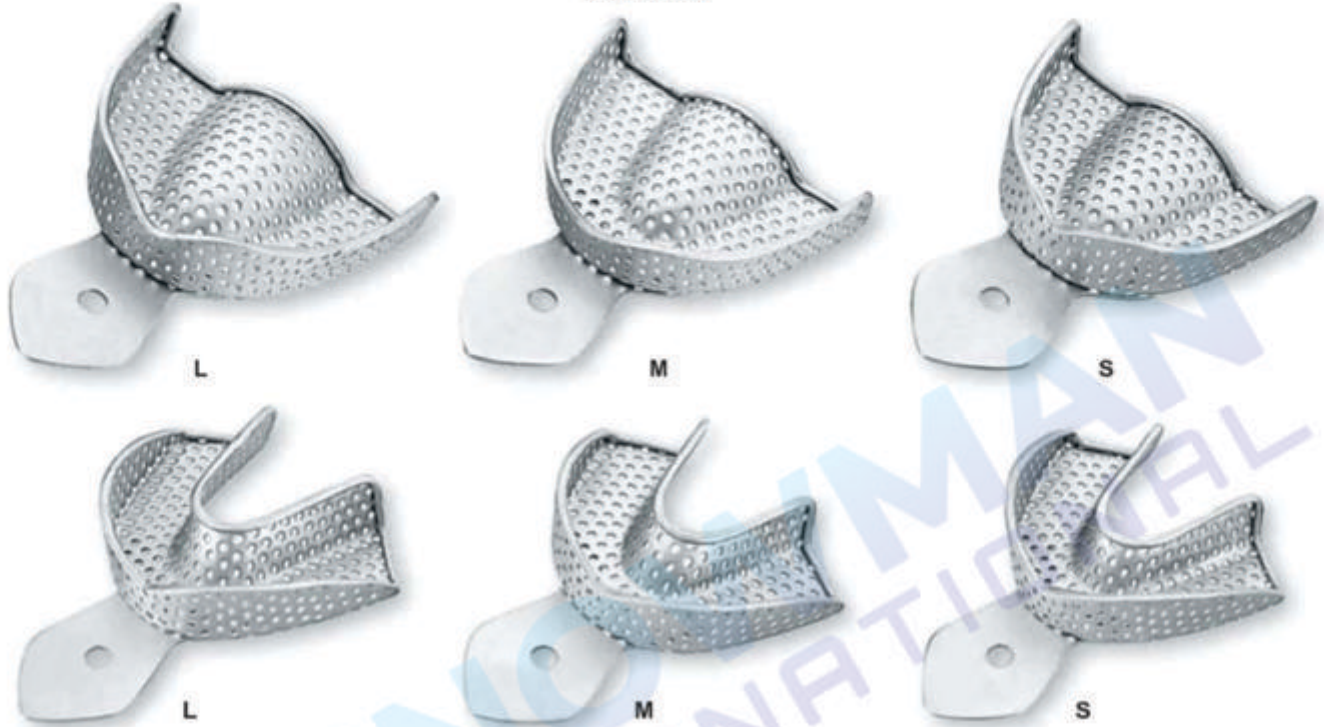

SI-3143 SET OF 06 PCS
Upper: S, M, L
Lower: S, M, L

PERFORATED WITH RIM LOCK

Set of 8 Pcs

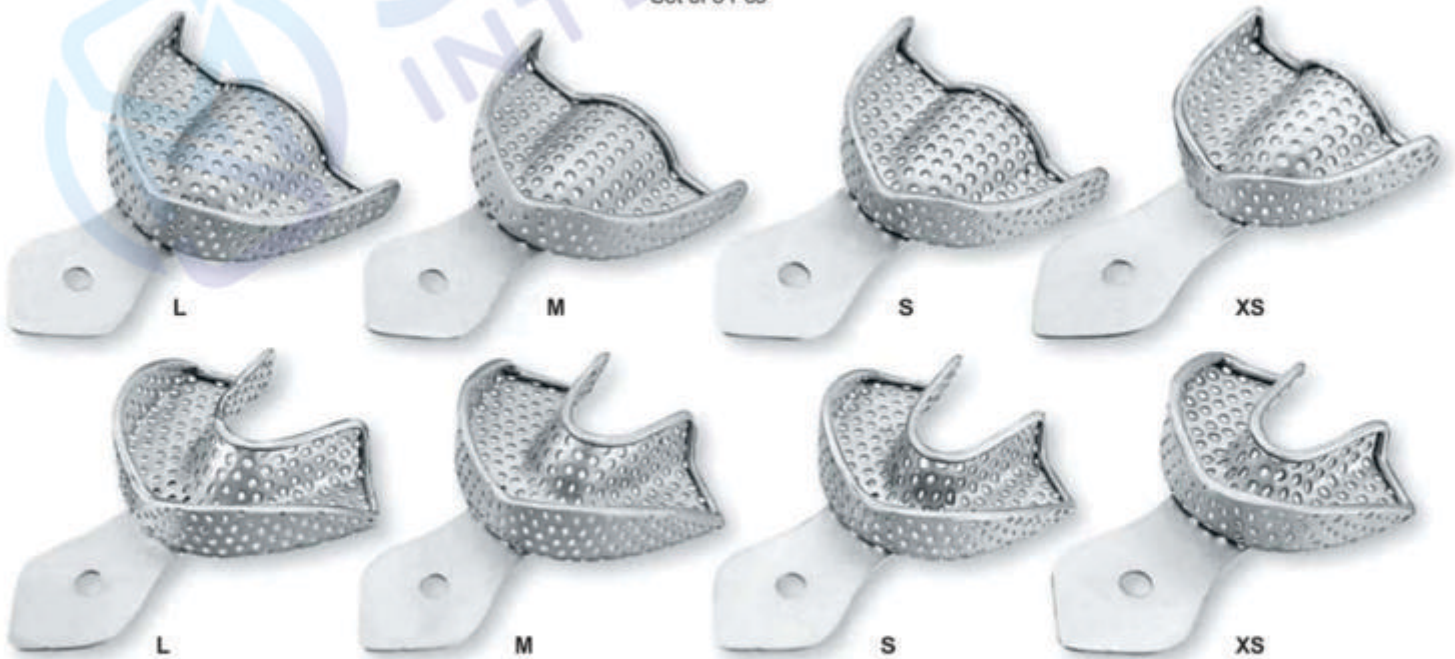

SI-3144 SET OF 08 PCS
Upper: XS, S, M, L
Lower: XS, S, M, L

SI-3145 SET OF 08 PCS
Upper: S, M, L, XL
Lower: S, M, L, XL

SI-3146 SET OF 10 PCS
Upper: XS, S, M, L, XL
Lower: XS, S, M, L, XL

IMPRESSION TRAYS

- Оттисные ложки
- Porte-empreinte
- Abdrucklöffel

- Відбиткові ложки
- Cubetas para impresiones
- صواني الانطباع

SOLID WITH RIM LOCK

Set of 6 Pcs



SI-3147 **SET OF 06 PCS**
Upper: S, M, L
Lower: S, M, L

SOLID WITH RIM LOCK

Set of 8 Pcs

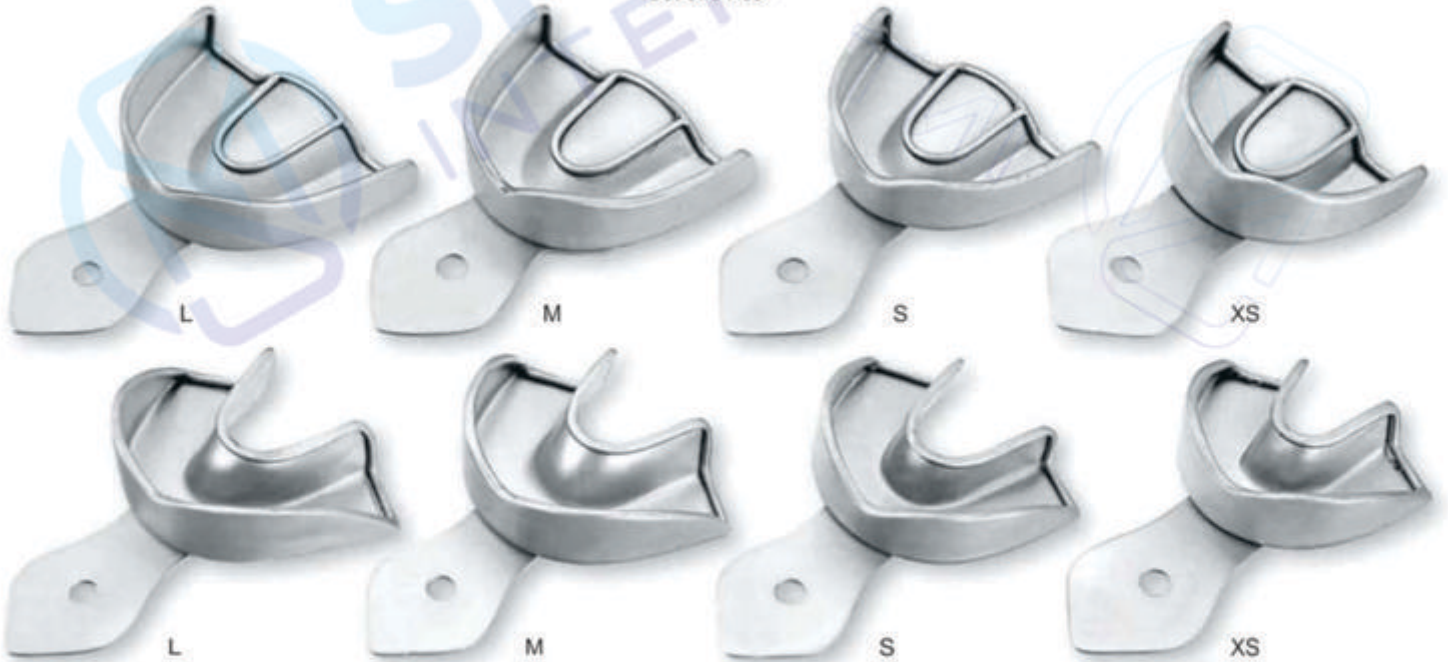

SI-3148 **SET OF 08 PCS**
Upper: XS, S, M, L
Lower: XS, S, M, L

SI-3149 **SET OF 08 PCS**
Upper: S, M, L, XL
Lower: S, M, L, XL

SI-3150 **SET OF 10 PCS**
Upper: XS, S, M, L, XL
Lower: XS, S, M, L, XL

IMPRESSION TRAYS

- Оттисные ложки
- Porte-empreinte
- Abdrucklöffel
- Відбиткові ложки
- Cubetas para impresiones
- صواني الاطباع

PERFORATED FULL DENTURE

Set of 8 Pcs

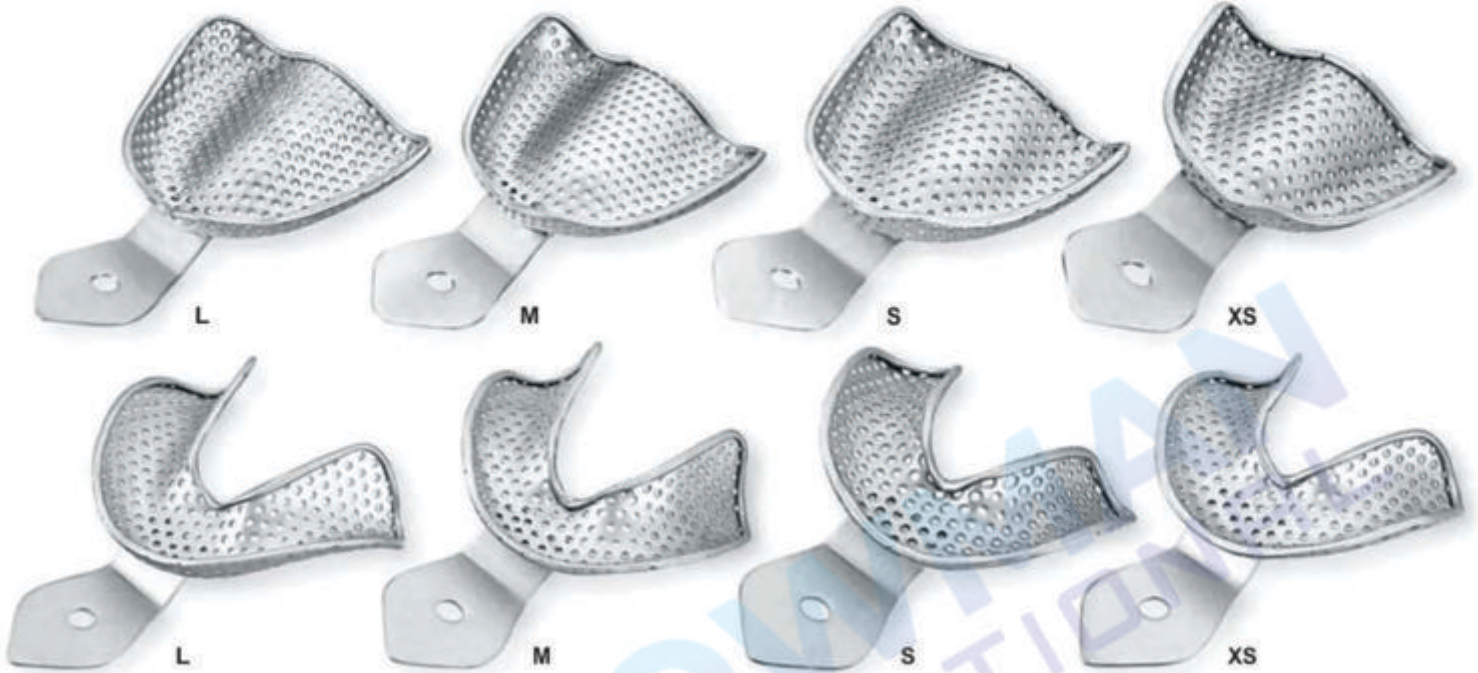

SI-3151 **SET OF 08 PCS**
Upper: S, M, L, XL
Lower: S, M, L, XL

SI-3152 **SET OF 08 PCS**
Upper: S, M, L
Lower: S, M, L

SOLID FULL DENTURE

Set of 8 Pcs



SI-3153 **SET OF 08 PCS**
Upper: S, M, L, XL
Lower: S, M, L, XL

SI-3154 **SET OF 06 PCS**
Upper: S, M, L
Lower: S, M, L

IMPRESSION TRAYS

- Оттисные ложки
- Porte-empreinte
- Abdrucklöffel
- Відбиткові ложки
- Cubetas para impresiones
- صواني الانطباع

Perforated Without Rim Lock

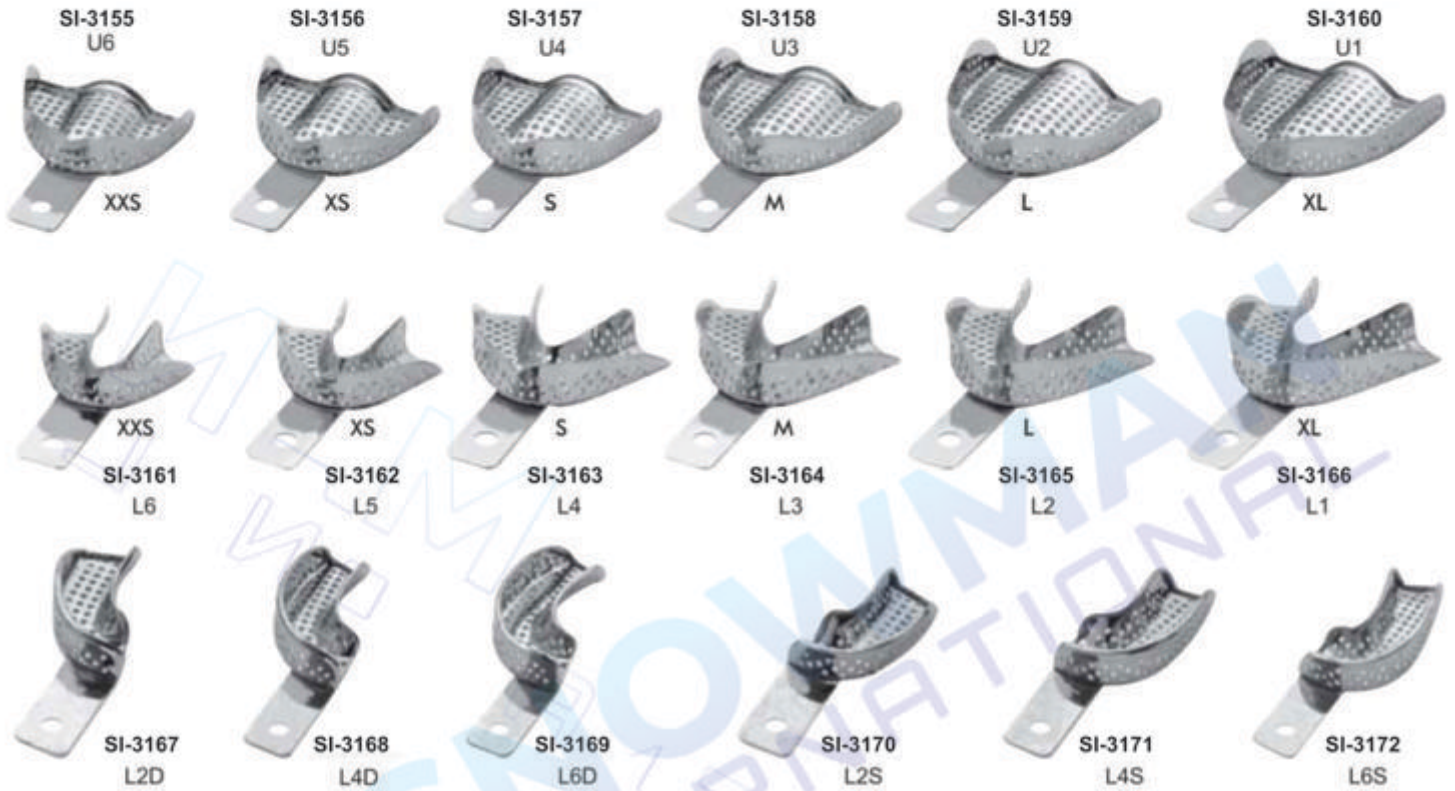

Solid With Rim Lock

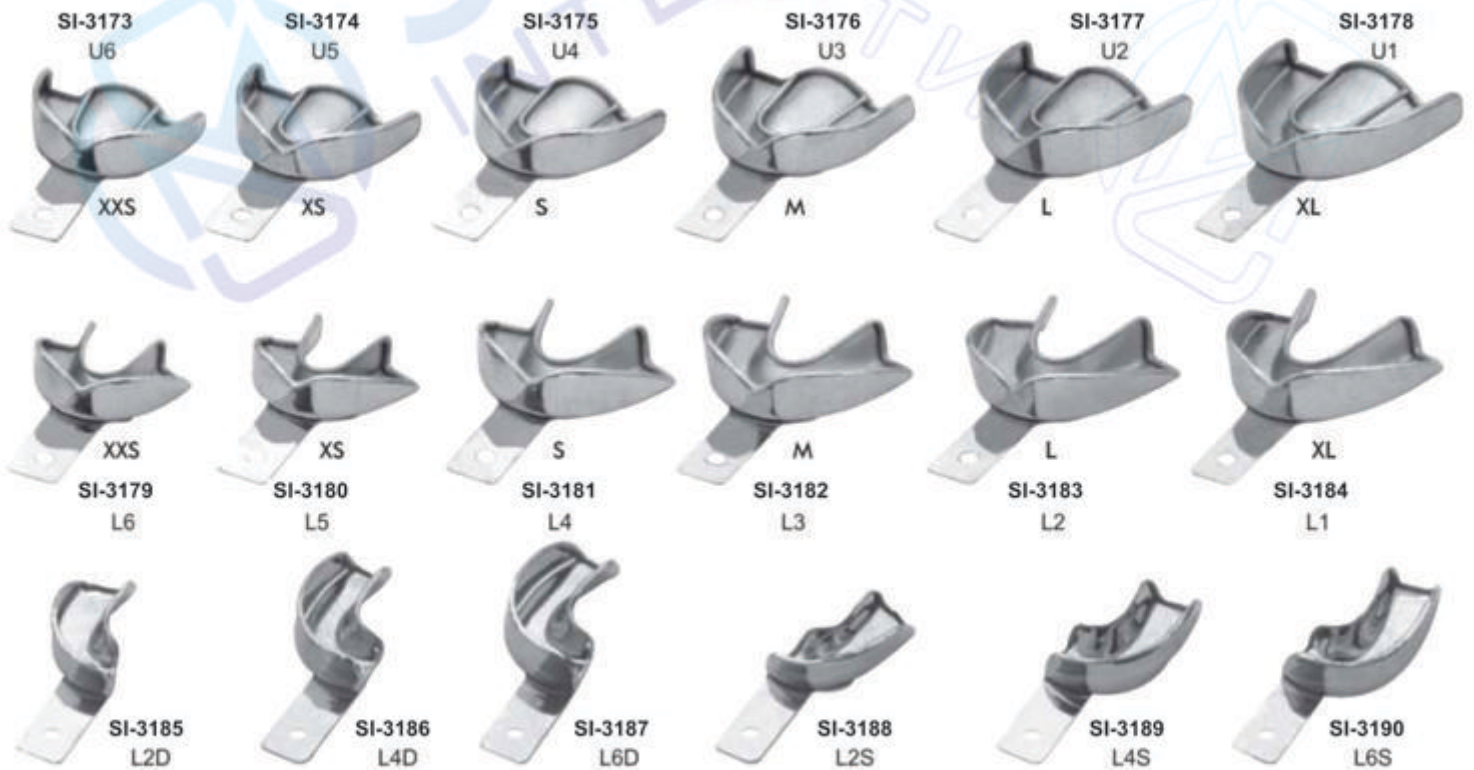





Scalers Tray
SI-3191 200 x 100 mm



Scalers Trays
SI-3192 205 x 115 x 17 mm
SI-3193 205 x 152 x 17 mm
SI-3194 290 x 115 x 17 mm

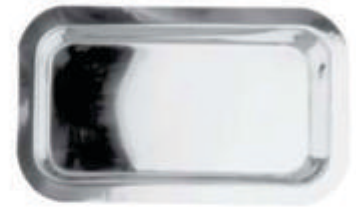

Instruments Trays
SI-3195 200 x 110 x 30 mm
SI-3196 215 x 115 x 35 mm
SI-3197 220 x 130 x 30 mm
SI-3198 230 x 125 x 35 mm
SI-3199 245 x 140 x 40 mm
SI-3200 285 x 160 x 45 mm
SI-3201 315 x 175 x 50 mm
SI-3202 330 x 185 x 50 mm



Instruments Trays
SI-3203 150 x 100 x 50 mm
SI-3204 200 x 100 x 50 mm
SI-3205 220 x 120 x 50 mm
SI-3206 240 x 140 x 50 mm
SI-3207 200 x 150 x 50 mm
SI-3208 250 x 200 x 50 mm
SI-3209 300 x 250 x 50 mm
SI-3210 300 x 200 x 50 mm
SI-3211 350 x 250 x 50 mm
SI-3212 400 x 300 x 50 mm
SI-3213 450 x 300 x 50 mm
SI-3214 450 x 350 x 50 mm



Instruments Trays With Lid
SI-3215 150 x 100 x 50 mm
SI-3216 200 x 100 x 50 mm
SI-3217 220 x 120 x 50 mm
SI-3218 240 x 140 x 50 mm
SI-3219 200 x 150 x 50 mm
SI-3220 250 x 200 x 50 mm
SI-3221 300 x 250 x 50 mm
SI-3222 300 x 200 x 50 mm
SI-3223 350 x 250 x 50 mm
SI-3224 400 x 300 x 50 mm
SI-3225 450 x 300 x 50 mm
SI-3226 450 x 350 x 50 mm



Mayo Tray Perforated
SI-3227 150 x 100 x 25 mm
SI-3228 200 x 100 x 25 mm
SI-3229 220 x 120 x 25 mm
SI-3230 240 x 140 x 25 mm
SI-3231 200 x 150 x 25 mm
SI-3232 250 x 200 x 25 mm
SI-3233 300 x 250 x 25 mm
SI-3234 300 x 200 x 25 mm
SI-3235 350 x 250 x 25 mm
SI-3236 400 x 300 x 25 mm
SI-3237 450 x 300 x 25 mm
SI-3238 450 x 350 x 25 mm



Scaler Tray
SI-3239 200 x 115 mm
SI-3240 205 x 150 mm
SI-3241 290 x 150 mm
SI-3242 300 x 200 mm



Instruments Tray Perforated
SI-3243 150 x 100 x 50 mm
SI-3244 200 x 100 x 50 mm
SI-3245 220 x 120 x 50 mm
SI-3246 240 x 140 x 50 mm
SI-3247 200 x 150 x 50 mm
SI-3248 250 x 200 x 50 mm
SI-3249 300 x 250 x 50 mm
SI-3250 300 x 200 x 50 mm
SI-3251 350 x 250 x 50 mm
SI-3252 400 x 300 x 50 mm
SI-3253 450 x 300 x 50 mm
SI-3254 450 x 350 x 50 mm

Sterilizing boxes & instruments Trays



Instruments Box with Hooks	
SI-3255	170 x 70 x 30 mm
SI-3256	180 x 80 x 40 mm
SI-3257	200 x 100 x 40 mm
SI-3258	200 x 100 x 50 mm
SI-3259	220 x 120 x 50 mm
SI-3260	250 x 150 x 50 mm
SI-3261	250 x 200 x 50 mm
SI-3262	300 x 150 x 60 mm
SI-3263	300 x 200 x 50 mm
SI-3264	350 x 250 x 50 mm
SI-3265	400 x 200 x 100 mm
SI-3266	450 x 250 x 50 mm



Instruments Box	
SI-3267	170 x 70 x 30 mm
SI-3268	180 x 80 x 40 mm
SI-3269	200 x 100 x 40 mm
SI-3270	200 x 100 x 50 mm
SI-3271	220 x 120 x 50 mm
SI-3272	250 x 150 x 50 mm
SI-3273	250 x 200 x 50 mm
SI-3274	300 x 150 x 60 mm
SI-3275	300 x 200 x 50 mm
SI-3276	350 x 250 x 50 mm
SI-3277	400 x 200 x 100 mm
SI-3278	450 x 250 x 50 mm



Instruments Box Perforated	
SI-3279	170 x 70 x 30 mm
SI-3280	180 x 80 x 40 mm
SI-3281	200 x 100 x 40 mm
SI-3282	200 x 100 x 50 mm
SI-3283	220 x 120 x 50 mm
SI-3284	250 x 150 x 50 mm
SI-3285	250 x 200 x 50 mm
SI-3286	300 x 150 x 60 mm
SI-3287	300 x 200 x 50 mm
SI-3288	350 x 250 x 50 mm
SI-3289	400 x 200 x 100 mm
SI-3290	450 x 250 x 50 mm



Gloves Box
SI-3291 300 x 150 mm



Catheters Tray with lid
SI-3292 200 x 60 x 40 mm
SI-3293 200 x 90 x 40 mm
SI-3294 320 x 95 x 50 mm
SI-3295 328 x 90 x 50 mm
SI-3296 365 x 90 x 50 mm
SI-3297 440 x 115 x 50 mm

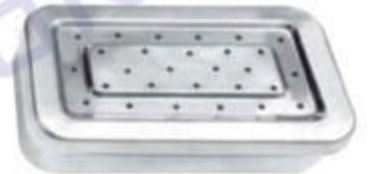

Box With Filter
SI-3298 100 x 50 mm
SI-3299 250 x 150 mm
SI-3300 150 x 65 mm
SI-3301 200 x 100 mm
SI-3302 300 x 200 mm



Instruments Trays With Cover
SI-3303 210 x 110 x 50 mm
SI-3304 240 x 160 x 50 mm
SI-3305 300 x 180 x 50 mm
SI-3306 360 x 210 x 50 mm
SI-3307 400 x 230 x 55 mm

Instruments Trays Without Cover
SI-3308 210 x 110 x 50 mm
SI-3309 240 x 160 x 50 mm
SI-3310 300 x 180 x 50 mm
SI-3311 360 x 210 x 50 mm
SI-3312 400 x 230 x 55 mm



Instruments Box with lid
SI-3313 170 x 70 x 30 mm
SI-3314 180 x 80 x 40 mm
SI-3315 200 x 100 x 40 mm
SI-3316 200 x 100 x 50 mm
SI-3317 220 x 120 x 50 mm
SI-3318 250 x 150 x 50 mm
SI-3319 250 x 200 x 50 mm
SI-3320 300 x 150 x 60 mm
SI-3321 300 x 200 x 50 mm
SI-3322 350 x 250 x 50 mm
SI-3323 400 x 200 x 100 mm
SI-3324 450 x 250 x 50 mm



Kidney Tray
 SI-3325 160 mm
 SI-3326 200 mm
 SI-3327 250 mm
 SI-3328 280 mm
 SI-3329 300 mm



Kidney Tray Shallow
 SI-3335 170 mm
 SI-3336 220 mm
 SI-3337 240 mm



Kidney Tray With Cover
 SI-3330 160 mm
 SI-3331 200 mm
 SI-3332 250 mm
 SI-3333 280 mm
 SI-3334 300 mm



Kidney Tray
 SI-3338 160 mm
 SI-3339 200 mm
 SI-3340 250 mm
 SI-3341 280 mm
 SI-3342 300 mm



Forceps Jars
 SI-3343 30 x 90 mm
 SI-3344 50 x 100 mm
 SI-3345 50 x 130 mm
 SI-3346 50 x 175 mm
 SI-3347 75 x 100 mm
 SI-3348 75 x 130 mm
 SI-3349 75 x 175 mm
 SI-3350 100 x 175 mm
 SI-3351 100 x 200 mm



Methot Jar Without Lid
 SI-3352



Dressing Jar / Cotton Container
 SI-3353 80 x 80 mm
 SI-3354 100 x 60 mm
 SI-3355 100 x 80 mm
 SI-3356 100 x 100 mm
 SI-3357 120 x 80 mm
 SI-3358 120 x 100 mm
 SI-3359 150 x 100 mm
 SI-3360 150 x 150 mm
 SI-3361 180 x 150 mm
 SI-3362 180 x 180 mm
 SI-3363 200 x 200 mm
 SI-3364 240 x 240 mm



Sputum Cup
 SI-3365



Dressing Jar With Lid & Knob
 SI-3366 80 x 80 mm
 SI-3367 90 x 90 mm
 SI-3368 100 x 100 mm
 SI-3369 120 x 120 mm
 SI-3370 100 x 130 mm
 SI-3371 150 x 150 mm
 SI-3372 125 x 170 mm



Round Bowls
 SI-3373 80 x 35 mm
 SI-3374 125 x 60 mm



Spirit Lamp
SI-3375



Spirit Lamp
SI-3376



Spirit Lamp
SI-3377



Cotton Holding Jar
SI-3378



Cotton Holder
SI-3379



Cotton Holder
SI-3380



Cotton Wool Dispenser Acc.
to Methot
SI-3381



Needle Sterilization Tub
SI-3382



Round Endodontic Boxes
complete with lid
SI-3383 Ø mm. 94 - h. mm. 70



Endodontic Box
SI-3384

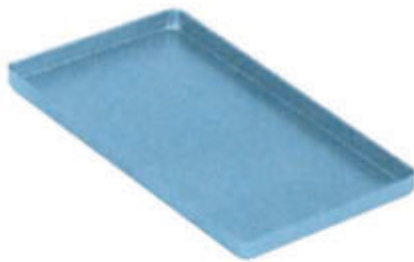

SI-3385
100 x 180 x 11mm
Mini size



SI-3386
100 x 180 x 11mm
Mini size



SI-3387
100 x 180 x 11mm
Mini size



SI-3388
100 x 180 x 11mm
Mini size



SI-3389
100 x 180 x 11mm
Mini size



Lid
Coperchio

SI-3390
103 x 182 x 10mm
Mini size



SI-3391
Silver

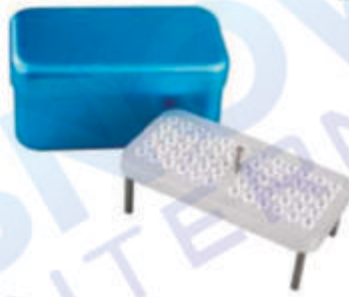

SI-3392 Blue
SI-3393 Red



SI-3394 Blue
SI-3395 Red



SI-3396
Silver



SI-3397
Green



SI-3399
Blue



SI-3398
Golden



SI-3400
Red



SI-3401
Silver



SI-3402
Midi
125 x 105 x 54mm



SI-3403
Maxi
204 x 105 x 54mm

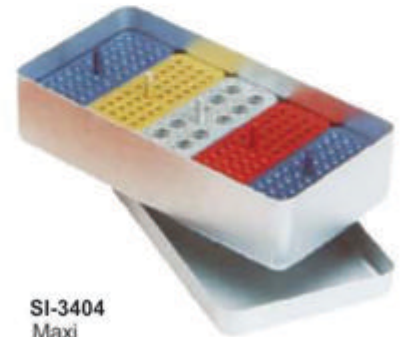

SI-3404
Maxi
204 x 105 x 54mm



Round Sterilizer Drum

SI-3405	mm. Ø 80 x 80 H
SI-3406	mm. Ø 125 x 80 H
SI-3407	mm. Ø 125 x 100 H
SI-3408	mm. Ø 125 x 125 H
SI-3409	mm. Ø 150 x 80 H
SI-3410	mm. Ø 150 x 100 H
SI-3411	mm. Ø 150 x 130 H
SI-3412	mm. Ø 150 x 150 H
SI-3413	mm. Ø 150 x 190 H
SI-3414	mm. Ø 190 x 125 H
SI-3415	mm. Ø 190 x 145 H
SI-3416	mm. Ø 190 x 165 H
SI-3417	mm. Ø 190 x 190 H
SI-3418	mm. Ø 190 x 240 H
SI-3419	mm. Ø 190 x 290 H
SI-3420	mm. Ø 240 x 120 H
SI-3421	mm. Ø 240 x 145 H
SI-3422	mm. Ø 240 x 165 H
SI-3423	mm. Ø 240 x 190 H
SI-3424	mm. Ø 240 x 240 H
SI-3425	mm. Ø 240 x 290 H
SI-3426	mm. Ø 240 x 340 H
SI-3427	mm. Ø 240 x 390 H
SI-3428	mm. Ø 290 x 145 H
SI-3429	mm. Ø 290 x 165 H
SI-3430	mm. Ø 290 x 190 H
SI-3431	mm. Ø 290 x 240 H
SI-3432	mm. Ø 290 x 290 H
SI-3433	mm. Ø 290 x 340 H
SI-3434	mm. Ø 290 x 390 H
SI-3435	mm. Ø 340 x 145 H
SI-3436	mm. Ø 340 x 165 H
SI-3437	mm. Ø 340 x 190 H
SI-3438	mm. Ø 340 x 240 H
SI-3439	mm. Ø 340 x 290 H
SI-3440	mm. Ø 340 x 340 H
SI-3441	mm. Ø 340 x 390 H
SI-3442	mm. Ø 390 x 140 H
SI-3443	mm. Ø 390 x 165 H
SI-3444	mm. Ø 390 x 190 H
SI-3445	mm. Ø 390 x 240 H
SI-3446	mm. Ø 390 x 290 H
SI-3447	mm. Ø 390 x 340 H
SI-3448	mm. Ø 390 x 390 H
SI-3449	mm. Ø 390 x 490 H

Round Sterilizer Drums "Filter"

SI-3450	mm. Ø 80 x 80 H
SI-3451	mm. Ø 125 x 80 H
SI-3452	mm. Ø 125 x 100 H
SI-3453	mm. Ø 125 x 125 H
SI-3454	mm. Ø 150 x 100 H
SI-3455	mm. Ø 150 x 130 H
SI-3456	mm. Ø 150 x 150 H
SI-3457	mm. Ø 150 x 190 H
SI-3458	mm. Ø 190 x 145 H
SI-3459	mm. Ø 190 x 165 H
SI-3460	mm. Ø 190 x 190 H
SI-3461	mm. Ø 190 x 240 H
SI-3462	mm. Ø 240 x 145 H
SI-3463	mm. Ø 240 x 165 H
SI-3464	mm. Ø 240 x 190 H
SI-3465	mm. Ø 240 x 240 H
SI-3466	mm. Ø 240 x 290 H
SI-3467	mm. Ø 240 x 340 H
SI-3468	mm. Ø 240 x 390 H
SI-3469	mm. Ø 290 x 145 H
SI-3470	mm. Ø 290 x 165 H
SI-3471	mm. Ø 290 x 190 H
SI-3472	mm. Ø 290 x 240 H
SI-3473	mm. Ø 290 x 290 H
SI-3474	mm. Ø 290 x 340 H
SI-3475	mm. Ø 290 x 390 H
SI-3476	mm. Ø 340 x 145 H
SI-3477	mm. Ø 340 x 165 H
SI-3478	mm. Ø 340 x 190 H
SI-3479	mm. Ø 340 x 240 H
SI-3480	mm. Ø 340 x 290 H
SI-3481	mm. Ø 390 x 140 H
SI-3482	mm. Ø 390 x 165 H
SI-3483	mm. Ø 390 x 190 H
SI-3484	mm. Ø 390 x 240 H
SI-3485	mm. Ø 390 x 290 H
SI-3486	mm. Ø 390 x 340 H
SI-3487	mm. Ø 390 x 490 H

Round Bowls With Cover

SI-3488	Ø 40 mm ml.30
SI-3489	Ø 60 mm ml.50
SI-3490	Ø 80 mm ml.150
SI-3491	Ø 100 mm ml.250
SI-3492	Ø 120 mm ml.450
SI-3493	Ø 150 mm ml.750
SI-3494	Ø 180 mm ml.1500
SI-3495	Ø 200 mm ml.2100
SI-3496	Ø 250 mm ml.3500

Round Bowls With Out Cover

SI-3497	Ø 40 mm ml.30
SI-3498	Ø 60 mm ml.50
SI-3499	Ø 80 mm ml.150
SI-3500	Ø 100 mm ml.250
SI-3501	Ø 120 mm ml.450
SI-3502	Ø 150 mm ml.750
SI-3503	Ø 180 mm ml.1500
SI-3504	Ø 200 mm ml.2100
SI-3505	Ø 250 mm ml.3500

INSTRUMENTS MANAGEMENT SYSTEM

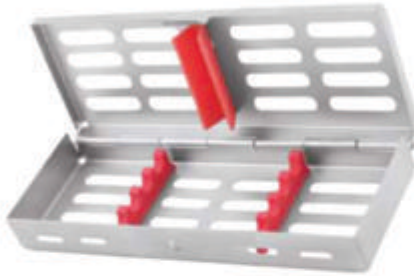

Cassette For 4 Instruments
SI-3506

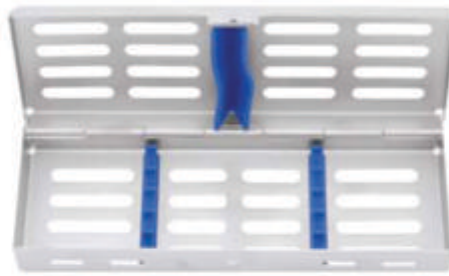

Cassette For 5 Instruments
SI-3507

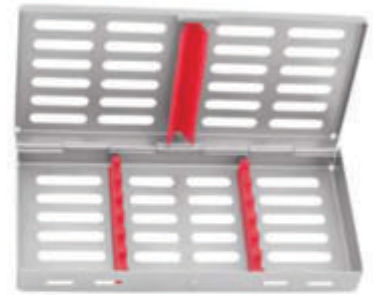

Cassette For 6 Instruments
SI-3508



Cassette For 7 Instruments
SI-3509



Cassette For 10 Instruments
SI-3510

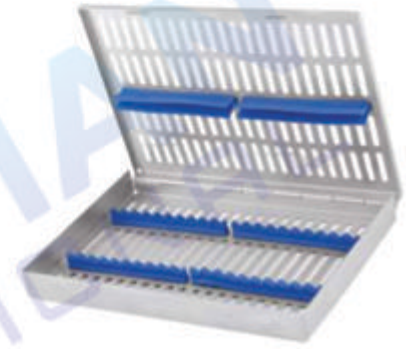

Cassette For 20 Instruments
SI-3511

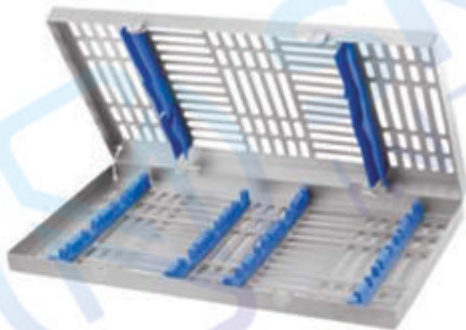

Cassette For Extraction Forceps
SI-3512



Cassette For Root Elevator
SI-3513



SI-3514
Cassette Tray
15 Pcs



SI-3515
Cassette Tray
15 Pcs

STERILIZING MESH TRAY

Different sizes & dimensions are available at buyer's demand



MESH TRAYS
SI-3516
Different sizes & dimensions are available at buyer's demand

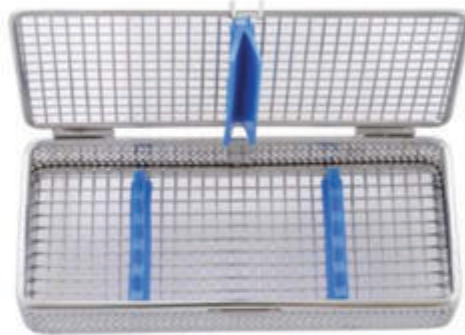

MESH TRAYS
SI-3517
05 Pcs



MESH TRAYS
SI-3518
07 Pcs



MESH TRAYS
SI-3519
10 Pcs



MESH TRAYS
SI-3520
20 Pcs



SI-3521
Mesh Cassettes
5 Pieces, 7 Pieces, 10 Pieces, 15 Pieces & 20 Pieces

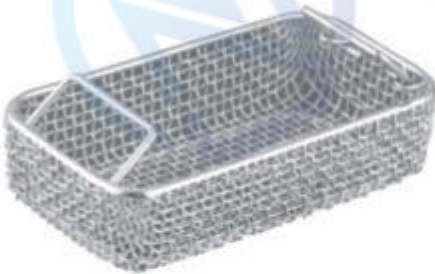

MESH TRAY
SI-3522 240x130x50mm
SI-3523 240x130x60mm
SI-3524 240x250x50mm
SI-3525 240x250x60mm
SI-3526 480x250x50mm
SI-3527 480x250x60mm
SI-3528 480x250x70mm



MESH TRAY
SI-3529 240x250x 50mm
SI-3530 240x250x 60mm
SI-3531 240x250x 70mm
SI-3532 480x250x 50mm
SI-3533 480x250x 60mm
SI-3534 480x250x 70mm
SI-3535 480x250x100mm

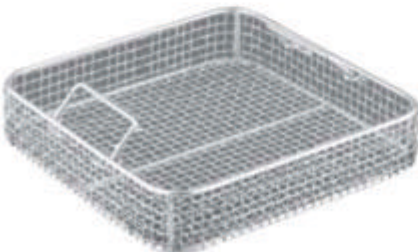

MESH TRAY
SI-3536 240x250x50mm
SI-3537 240x250x60mm
SI-3538 240x250x70mm
SI-3539 280x250x50mm
SI-3540 280x250x60mm



MESH TRAY
SI-3541 280x250x 70mm
SI-3542 280x250x100mm
SI-3543 280x250x 50mm
SI-3544 280x280x 60mm
SI-3545 280x280x 70mm
SI-3546 300x280x 60mm



SI-3547
18×7×3.5cm
5 Instruments Cassette
Detachable Lids
+
5 Instruments Cassette Hinged
Lids with button Lock



SI-3548
29×18.5×3.5cm
20 Instruments Cassette Hinged
Lids with surgical kit fitting,
button lock



Instruments Cassette
SI-3549 5 Pieces Cassette
SI-3550 7 Pieces Cassette
SI-3551 10 Pieces Cassette



SI-3552
18×11×3.5cm
Extra large cassette for 6
Instruments, with compartment
for small parts hinged lids

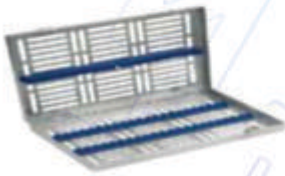

SI-3553
29×18.5×3.5cm
20 Instruments Cassette
Detachable Lids
+
20 Instruments Cassette Hinged
Lids with button Lock

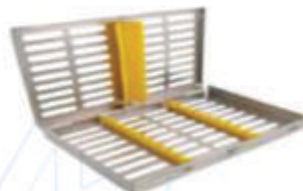

SI-3554
10×13×2.2cm
10 Instruments Cassette Hinged
Lids, Click Lock Available in 2
designs

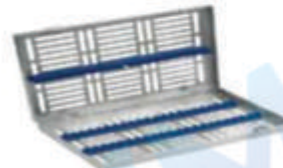

SI-3555
29×18.5×3.5cm
20 Instruments Cassette Detachable
Lids with elevator fitting
+
20 Instruments Cassette Hinged
Lids with elevator fitting , button lock



SI-3556
18×9×2.2cm
7 Instruments Cassette Hinged
Lids, Click Lock, Available in 2
designs



SI-3557
21×14×3.5cm
15 Instruments cassette,
Detachable lids, button lock



SI-3558
21×14×3.5cm
15 Instruments cassette,
detachable lids, button
lock, with fitting of micro
surgery kit



SI-3559
21×14×4.5cm
8 pcs luxator/elevator
cassette, Detach0
able lids, button lock



SI-3560
15×9×5cm
Box for dental implant tools and
surgical kits, Capacity:8
tools, 18 tools, 24 Tools, 58 Tools
+ removable compartment



Instruments Tray Perforated
SI-3561 288 x 187 x 40 mm



Instruments Tray Perforated Base
SI-3562 288 x 187 x 40 mm



Instruments Tray Solid Base
SI-3563 288 x 187 x 40 mm



SI-3564 Implant Basic Starter Kit 11 instruments with case



SI-3565 Crown Bridge Set Instruments with Case



SI-3566 Bone Curettes Spoon Style set of 4 with Metal Case



SI-3567 Peritome Set of 2 with Blue Nitrate Tips and Metal Case



SI-3568 Root Fragment Removal elevators, Set of 4 with Metal Case



SI-3569 Peritome Set of 3 Gold Handles Serrated Blades with Metal Case

DESCRIPTION PAGE#

A

A COSMETIC CONTOURING IMPLANTOLOGY 148

AB1 BOGHOSIAN IMPLANTOLOGY 147

AB2 BOGHOSIAN IMPLANTOLOGY 147

ABOU-RASS EXPLORERS 54

ACUTE IMPLANTOLOGY 161

ADAMS PLIER 133

ADAMS PLIER ROUND BOX 133

ADAMS PLIERS FOR HOOKS AND BENDING 138

ADAMS, SMALL WIRE BENDING AND LOOP FORMING PLIERS 132

ADERER CLAMP THREE JAW WIRE BENDING PLIER 138

ADERER FACEBOW LOOP FORMING PLIERS 134

ADERER LARGE WIRE BENDING AND LOOP FORMING PLIERS 133

ADERER PLIER 134

ADHESIVE REMOVING PLIERS 36,141

ADSON TX7 CURVED TISSUE FORCEPS 169

ADSON BROWN TWEEZERS 53

ADSON CARBIDE TIPPED TISSUE FORCEPS 169

ADSON NEEDLE HOLDERS 107

ADSON-TC TWEEZERS 53

ADULT PALATAL DENTAL PHOTOGRAPHIC MIRRORS 56

ALLIS HAEMOSTATIC FORCEPS 150

ALLIS-BABY HAEMOSTATIC FORCEPS 150

ALL PURPOSE PLIERS 109

ALUMINUM CALIPER 127

ALM RETRACTOR 162

AMALGAM CARRIERS 117

AMALGAM INSTRUMENTS 118,117

AMALGAM WELL 115,117

ANATOMIC HANDLE EXPLORERS 54

ANDREWS FILLING INSTRUMENTS 87

ANGLE HOW PLIER 138

ANGLED DIRECT BOND BRACKET REMOVER TC 139

ANGLED EXTRACTING FORCEPS FOR UPPER ROOTS 83

ANGLED UTILITY PLIERS 136

ANSWORTH RUBBER DAM CLAMPS FORCEPS 111

ANTERIOR 58

APEX FORCEPS LOWER ROOT DEEP ROOT PICK 06

APEX FORCEPS LOWER UNIVERSAL DEEP ROOT PICK 05

APEXO ROOT ELEVATORS 29

APICAL RETENTION FORCEPS 23

APICAL ROOT ELEVATORS 31,33

ARCH BENDING PLIERS 38,143

ARROW CLASP FORMING PLIERS 139

ARTICULATORS 87

ASPIRATING SYRING 27

ATRAUMATIC TWEEZERS 52

ATRAUMATIC WITH LOCK TWEEZERS 52

B

BABY TOOTH EXTRACTION FORCEPS SET OF 7 PIECES 06

BACK ACTION FILLING INSTRUMENTS 88

BACKHAUS HAEMOSTATIC FORCEPS 110

BACKHAUS TOWEL CLAMPS 110

BACOLITE HANDLE WAX KNIVES 96

BALL BURNISHERS 71

BALL FILLING INSTRUMENTS 93

BALL SOCKET NOT-PERFORATING AND NOT-DAMAGING 150

BALLACORN FILLING INSTRUMENTS 88

BAND REMOVING PLIERS 32,138

BAND SEATER AUTO CLEAVABLE 129

BAND SEATER AUTO CLEAVABLE ROUND SHAPE 129

BAND SEATER AUTO CLEAVABLE SQUARE SHAPE 129

BAND SEATER AUTO CLEAVABLE TRIANGLE SHAPE 129

BAND SEATING & REMOVING INSTRUMENTS 129

BAND SEATING & REMOVING SILICON GRP 129

BAND SEATING PLIERS 141

BANDS & CROWNS PLIER 134

BARRAQUER TC NEEDLE HOLDERS 109

BASINS FOR BONE 174

BAUMGARTNER NEEDLE HOLDERS 06,107

BAYONET ROOTS ELEVATOR SET 36

BEAVERTAIL FILLING INSTRUMENTS 88

BEEBEE GUM SCISSORS 106

BEERENDONK CALIPER 127

BEIN ROOT ELEVATORS 29,40

BENDING PLIER 138

BESEK COMPOSITE INSTRUMENTS 75

BESEK COMPOSITE MODELLING INSTRUMENTS 82

BESEK COMPOSITE PLUGGERS INSTRUMENTS 82

BESSEK PLUGGERS 76

BEYER BONE ROUNDING 25

BRANGLE SCALER 67

BIRD BEAK PLIER 38,141

BIRD BEAK PLIER FOR BENDING 138

BIRD BEAK PLIER STANDARD 133

BIRD BEAK WIRE BENDING & CUTTING PLIERS 134

BIRD BEAK WIRE BENDING PLIER 133

BISHOP RETRACTORS 101

BLACK FILLING INSTRUMENTS 80,87

BLACK SCALER 66

BLACK TITANIUM COLOUR COATED INSTRUMENTS 147,148,149

BLADE AND PUSHER 166

BLUE TITANIUM COATED BONE GRAFTING INSTRUMENTS 59,187

SET OF 7 PCS WITH CASSETTE 159

BLUMENTHAL BONE ROUNDING 25

BOLEY GAUGE 127

BONE BRACKET GAUGE 125

BONE CARRIER TITANIUM 150

BONE CRUSHER 174

BONE CRUSHER TITANIUM METAL CUTTER 174

BONE EXPANDER KIT 178

BONE EXPANDER SCREW & SURGICAL KITS 178

BONE FILES 119

BONE GRAFT 158

BONE GRAFT IMPLANTOLOGY 156

BONE GRAFT PACKER 164

BONE GRAFT/CARRIER TITANIUM 167

BONE GRAFTING INSTRUMENTS COMPACTOR /TAMPERS 166

BONE INJECTORS, COLLECTORS & SUCTION TUBE 173

BONE MILL 174

BONE ROUNDING 25

BONE SCRAPER 173

BONE SCRAPER STRAIGHT & CURVED 173

BONE SPOON/PACKER 166

DESCRIPTION PAGE#

BONE THICKNESS GAUGE 146

BONE UNIVERSAL KIT 176

BONE WELL 174

BOX FOR DENTAL IMPLANT TOOLS AND SURGICAL KITS 191

BOX JOINT PLIERS 132,133,134

BRACKET HOLDER TWEEZERS 128

BRACKET PLACER TWEEZERS 128

BRACKET PLACING TWEEZERS 128

BRACKET REMOVING PLIER CURVED 132

BRACKET REMOVING PLIER ROUND BOX 132

BRACKET REMOVING PLIERS ANGLED 136

BRACKET REMOVING PLIERS STRAIGHT 138

BRACKET REMOVING PLIERS WITH PLASTIC TIP 138

BRACKET TWEEZERS SLOT ALIGNER 128

BREWER RUBBER DAM CLAMPS FORCEPS 111

BRUENINGS RETRACTORS 101

BUCCAL AND LINGUAL/PALATAL SCALER 61

BUCCAL DENTAL PHOTOGRAPHIC MIRRORS 98

BUCCAL SURFACES SCALER 61

BUCCAL-SMALL DENTAL PHOTOGRAPHIC MIRRORS 98

BURNISHER FILLING INSTRUMENTS 79,88

BURNISHERS 149

BURNISHERS CONSERVATIVE TREATMENT 69,71

BUSER PERIODONTAL INSTRUMENTS 121

C

COSMETIC CONTOURING IMPLANTOLOGY 148

CARBIDE DIAMOND COATED POINT 24

CARRY FORCEPS 170

CARVER COMPOSITE MODELLING INSTRUMENTS 85

CARVERS INSTRUMENTS 89,90

CARVERS INSTRUMENTS CASSETTE FOR 5 INSTRUMENTS 90

CASSETTE FOR INSTRUMENTS 162

CASTROVIEJO CALIPERS 126

CASTROVIEJO GUM SCISSORS 105

CASTROVIEJO MICRO SCISSORS 108

CASTROVIEJO NEEDLE HOLDERS 107,108

CATHETERS TRAY WITH LID BOX WITH FILTER 184

CATRIDGE SYRING 27

CEMENT SPATULAS 95

CERI SAW 124

CHEEK RETAINER 101

CHILD PALATAL DENTAL PHOTOGRAPHIC MIRRORS 98

CHIP BLOWER 116

CHISELS, BONE FILES & SPOON CURETTE 118

CHISELS SCALER 85,87

CHOMPRET ROOT ELEVATOR 42

CINCH BACK / TIE BACK DISTAL END BENDING PLIERS 137

CLAW/LIFT ROOTS ELEVATOR 37

COARSE SUCTION TUBES 178

COBRA IMPLANTOLOGY 156

COHEN UNIVERSAL EXTRACTING FORCEPS (AMERICAN PATTERN) 17

COLLEGE FORCEPS 51

COLLEGE TWEEZER 53

COLLEGE WITH LOCK TWEEZERS 52

COLLINS TONGUE FORCEPS 110

COLUMBIA RETRACTOR 99

COMBINATION RETRACTORS 101

COMELLAS FORCEPS ANATOMICAL HANDLE 26

COMPASSO DE WILLIS 127

COMPOSITE BALL PLUGGERS 76

COMPOSITE FILLING INSTRUMENTS 92,93

COMPOSITE FILLING INSTRUMENTS SET OF 6 PCS 153

COMPOSITE GOLD TIP INSTRUMENTS 83

COMPOSITE INSTRUMENTS 72,73

COMPOSITE INSTRUMENTS BLUE TITANIUM WITH CASSETTES 89

COMPOSITE INSTRUMENTS TITANIUM BLUE ENDOODONTIC 89

COMPOSITE MODELLING INSTRUMENTS 85

COMPOSITE PLUGGERS INSTRUMENTS 82,83

COMPOSITE/PLASTIC FILLING INSTRUMENTS 87

CONDENSER IMPLANTOLOGY 150,161

CONE-SOCKET MOUTH MIRRORS 49

CONE-SOCKET FRONT SURFACE MOUTH MIRRORS 49

CONE-SOCKET MIRROR HANDLES FOR MOUTH MIRRORS 50

CONE-SOCKET PLAIN MOUTH MIRRORS 49

CONE-SOCKET RHODIUM MOUTH MIRRORS 49

CONE-SOCKET SOLID HANDLES FOR MOUTH MIRRORS 50

CONE-SOCKET SOLID OCTAGONAL HANDLES FOR MOUTH MIRRORS 50

CONTOURING PLIER 134,138

COPERCHIO HOLLOWARE INSTRUMENTS 187

CORROSION-RESISTANT 145

COTTON HOLDER 76

COTTON HOLDING JAW 188

COTTON WOOL DISPENSER ACC. TO METHOT 188

COUPLAND ROOT ELEVATORS 34

CRANE KAPLAN TWEEZERS 53

CRILE-WOOD NEEDLE HOLDERS 106,107

CROWN REMOVER 114

CROWN SPREADERS 114

CRUCIBLE TONGS 124

CRUYER EXTRACTING FORCEPS (AMERICAN PATTERN) 12,13,19,20

CRUYER ROOT ELEVATORS 32

CUTTER 139,142

CUTTER, UTILITY PLIERS & WIRE FORMING PLIERS 141

D

DEAN GUM SCISSORS 105

DEBAKEY ATRAUMATIC TISSUE FORCEPS 169

DELUX BOLEY GAUGE 127

DELUXE BRACKET HOLDER 128

DELUXE BRACKET HOLDER TWEEZERS 128

DENHARD RETRACTORS - MOUTH GAGS 103

DENTAL PHOTOGRAPHIC MIRRORS 98

DENTAL SYRINGES 27

DENTAURUM CALIPER 127

DERF NEEDLE HOLDERS 106,107

DETAILING STEP PLIER 139

DETAILING STEP PLIERS / BAYONET BENDING PLIERS 137

DIAMOND COATED MARGIN TRIMMERS 65

DIRECT BOND BRACKET HOLDER TWEEZERS 128

DIRECT BOND BRACKET HOLDER TWEEZERS, SMALL TIP 128

DIRECT BONDING BRACKET HOLDERS 128

DIRECT BRACKET REMOVER TC 140

DISC SYSTEM DENTAL SYRINGES 27

DISSECTING SET SET OF 11 PCS 94

DISSECTING SET SET OF 9 PCS 94

DESCRIPTION PAGE#

DISTAL AMALGAM CARRIERS	117
DISTAL BENDER SILICON GRIP	129
DISTAL CUTTER	139
DISTAL END CUTTER	135
DISTAL END CUTTER FLUSH CUT	142
DISTAL END CUTTER, SAFETY HOLD PLIER (IDEAL FOR CUTTING WIRE) TC	140
DISTAL END WIRE CUTTERS & BRACKET REMOVER PLIERS	140
DISTAL SCALER	81,83
DOUBLE ENDED CEMENT SPATULA	131
DOUBLE ROUNDED JAW BENDING PLIERS	138
DOUBLE ENDED EXPLORERS	54
DRESSING TWEEZERS	52,53
DYNAMOMETER	148

E	
EASY ACCESS TWEEZERS	128
EBNETER SCALER	84
ELASTIC INSTRUMENT SILICON GRIP	129
ELASTIC SEPARATING PLIER	140
ELASTIC SEPARATING PLIER ROUND HANDLE	140
ELASTOMERIC LIGATURE PLACING FORCEPS WITH GROOVE FALCON	140
ELEVATORS SET OF 8 PCS	46
ELEVATORS SET OF 4 PCS	46
ELLIOT SIGVELAND RETAINERS	115
ENDO FINGER RULER SPAN MEASURE SCALE	125
ENDODONTIC BOX	186
ENDODONTIC EXPLORER	154
ENDODONTIC INSTRUMENTS	58
ERGO GRIP RETRACTOR	101
EURO BREECH LOADING DENTAL SYRINGES	27
EXCAVATORS EXPLORERS	51
EXCAVATOR INSTRUMENTS	74
EXCAVATORS	86
EXECT BRACKET HOLDER TWEEZERS	128
EXPLORERS	51,54,55,56
EXTRACTING FORCEPS (AMERICAN PATTERN)	126,24
EXTRACTING FORCEPS (ENGLISH PATTERN)	01to07,26

EXTRACTING FORCEPS (ENGLISH PATTERN) SET OF 10 PIECES	07
EXTRACTING FORCEPS	08
EXTRACTING FORCEPS AMERICAN ADULT SET OF 10 PCS	28
EXTRACTING FORCEPS AMERICAN ADULT SET OF 3 PCS	28
EXTRACTING FORCEPS CHILDREN PATTERN SET OF 10 PIECES	28
EXTRACTING FORCEPS ENGLISH ADULT SET OF 10 PCS	28
EXTRACTING FORCEPS ENGLISH ADULT SET OF 3 PCS	28
EXTRACTING FORCEPS PEDO SET OF 7 PCS	28
EXTRACTING FORCEPS SET	28
EXTRACTING FORCEPS SET OF 10 PIECES	28
EXTRACTING FORCEPS SET OF 10 PIECES	28
EXTRACTING FORCEPS SET OF 13 PIECES	28
EXTRA-FLEX IMPLANTOLOGY	147

F	
FALCON BEAK CONTOURING PLIERS	133,138
FARABEUF RETRACTORS SET OF 2 PICES)	103
FELDMAN RETRACTOR	103
FILLING INSTRUMENTS (GOLD POINTED)	91
FILLING INSTRUMENTS	87,88,91,93
FILLING INSTRUMENTS CONSERVATIVE TREATMENT	89,70,75,78,79,81,84
FIRST AID EXAMINATION SET OF 3 PICES	51
FLEXIBLE PERIOME	163
FLEXI THIN IMPLANTOLOGY	147
FLOOR ROOT ELEVATORS	29,33
FLUSH-CUT DISTAL AND CUTTING PLIERS	133
FLUSH-CUT DISTAL END CUTTER	135
FOERSTER DRESSING FORCEPS	110
FRAZIER SUCTION TUBES WITH FILTER	178
FREEDMAN 'DUCKHEAD'	149
FREEDMAN BURNISHERS	149
FREEDMAN LARGE CONTACT FORMING	149
FREEDMAN SMALL CONTACT FORMING	149
FREER PERIODONTAL INSTRUMENTS	121
FREER PERIOSTEEL ELEVATORS	120
FRET SAW	124
FRIEDMAN BONE ROUNDER	25
FRIEDMANN ROOT ELEVATOR	36
FRIEDMANNRICHARD PERIODONTAL INSTRUMENTS	122
FUZZI COMPOSITE MODELLING INSTRUMENTS	85

G	
GERALD TWEEZERS	82
GILLES TWEEZERS	52
GILLES NEEDLE HOLDER WITH SCISSORS	157
GLOVES BOX	184
GOLD COLOR SET DENTAL ORAL IMPLANTOLOGY SINUS SET OF 10 PCS WITH CASSETTE	158
GOLD MILL (LARGE)	174
GOLD MILL (SMALL)	174
GOLDMAN FOX SUPER CUT SCISSORS	108
GOLDMAN FOX EXPLORERS	55
GOLDMAN FOX SCISSORS	108
GOLDMAN FOX GUM SCISSORS	104,105
GOLDMAN FOX PERIODONTAL INSTRUMENTS	121
GOLDMANN FOX SCALER	84
GRACEY AFTER FIVE	80
GRACEY CURETTES SCALER	81
GRACEY CURETTES	59,63
GRACEY MINI FIVE	80
GRACEY SCALER	81
GRAFT MATERIAL SPOON CONCAVE TIP FOR LARGER GRAFTS	165
GRAFT PACKER	166
GRAFT PACKER CONCAVE	166
GRIPPER CARBIDE TIPPED TISSUE FORCEPS TC	169
GROTMAN CEMENT SPATULAS	95
GROSS MAIER DRESSING FORCEPS	110
GULDENER SCALER	84
GUM SCISSORS	104to108

H	
HAEMOSTATIC FORCEPS & TOWEL CLAMPS	110
HALSEY NEEDLE HOLDERS	106,107
HALSTEAD MOSQUITO HAEMOSTATIC FORCEPS	110
HALSTEAD MOSQUITO NEEDLE HOLDERS	107
HALTERPINZETTE WITH LOCK TWEEZERS	170

DESCRIPTION PAGE#

HAMMER HEAD DISTAL END BENDING PLIERS	137
HAMMER WITH WOODEN HANDLE	124
HANDLE ROUND HANDLES FOR MOUTH MIRRORS	50
HANDLES FOR MOUTH MIRRORS	50
HARD WIRE CUTTER	142
HARD WIRE CUTTER STRAIGHT	142
HARD WIRE CUTTER, 15° ANGLED	135
HARD WIRE CUTTER, 15° ANGLED NON-AUTOCALIVABLE	135
HARD WIRE CUTTER, STRAIGHT	135
HARD WIRE CUTTERS	140
HARRIS EXTRACTING FORCEPS (AMERICAN PATTERN)	13,18
HARTMANN (BABY MOSQUITO) NEEDLE HOLDERS	107
HEAT CARRIERS	57
HEBER BAYONET ROOTS ELEVATOR	40
HEBER ROOTS ELEVATOR	40
HEIDBRINK ROOT APPEX ELEVATOR	44
HEIDBRINK ROOT ELEVATORS	33,43
HEIDBRINK ROOTS ELEVATOR WARWICK-JAMES	44
HEIDEMANN FILLING INSTRUMENTS	93
HEIDEMANN SPATULAS	73
HEIGHT GAUGE 0.18 STAINLESS STEEL	125
HEIGHT GAUGE ALUMINIUM	125
HEMINGWAY TWEEZERS	53
HEX TORQUE WRENCH UNIVERSAL	177
HEXAGONAL HANDLES FOR MOUTH MIRRORS	50
HIRSCHFELD PERIODONTAL INSTRUMENTS	122
HIRT COMPOSITE MODELLING INSTRUMENTS	85
HIRT COMPOSITE PLUGGERS INSTRUMENTS	83
HIRT SCALER	66
HMG HEISTER	99
HOLLENBACK FILLING INSTRUMENTS	80,87
HOLLOW CHOP CONTOURING PLIERS	143
HOLLOW HANDLES FOR MOUTH MIRRORS	50
HOLLOW MIRROR, HANDLES FOR MOUTH MIRRORS	50
HOLLOWWARE INSTRUMENTS	183,184,186,187,190,191
HOLZ SCALER	65
HOOK CRIMPING PLIER ANGLED STRAIGHT TC	140
HOOK KNIVES	96
HOPSON FILLING INSTRUMENTS	78
HOW PLIER	132
HOW PLIER CURVED	132
HOW PLIERS OFFSET	141
HOW PLIERS STRAIGHT	141
HOW STRAIGHT UTILITY PLIERS	138
HOWARD PERIOSTEEL ELEVATORS	120
HULL EXTRACTING FORCEPS (AMERICAN PATTERN)	19
HYLIN CEMENT SPATULAS	95
HYLIN ROOTS ELEVATOR	39

I	
IMPLANT GAGES	145
IMPLANT SINUS LIFT INSTRUMENTS	161,182
IMPLANTOLOGY	145to178
IMPLANTOLOGY 8 PCS OF SET	161
IMPLANTOLOGY SET OF 2 COMPOSITE BLUE TIP INSTRUMENTS	154
IMPLANTOLOGY SET OF 3 COMPOSITE BLUE TIP INSTRUMENTS	154
IMPLANTOLOGY SET OF 4 COMPOSITE BLUE TIP INSTRUMENTS	154
IMPLANTOLOGY SET OF 5 COMPOSITE GOLD TIP INSTRUMENTS	154
IMPRESSION TRAYS	179to182
IMPRESSION TRAYS PERFORATED FULL DENTURE SET OF 8 PCS	181
IMPRESSION TRAYS PERFORATED WITHOUT RIM LOCK	182
IMPRESSION TRAYS SOLID FULL DENTURE SET OF 08 PCS	181
IMPRESSION TRAYS SOLID FULL DENTURE SET OF 8 PCS	181
IMPRESSION TRAYS SOLID WITH RIM LOCK	182
IMPRESSION TRAYS SOLID WITH RIM LOCK SET OF 06 PCS	180
IMPRESSION TRAYS SOLID WITH RIM LOCK SET OF 08 PCS	180
IMPRESSION TRAYS SOLID WITH RIM LOCK SET OF 10 PCS	180
INSTRUMENTS BOX	184
INSTRUMENTS BOX PERFORATED	184
INSTRUMENTS BOX WITH HOOKS	184
INSTRUMENTS BOX WITH LID	184
INSTRUMENTS CASSETTE 10 HINGED	191
INSTRUMENTS CASSETTE 10 PICES CASSETTE	191
INSTRUMENTS CASSETTE 15 SURGERY KIT	191
INSTRUMENTS CASSETTE	191
INSTRUMENTS CASSETTE 20 DETACHABLE	191
INSTRUMENTS CASSETTE 20 DETACHABLE LIDS	191
INSTRUMENTS CASSETTE 20 HINGED	191
INSTRUMENTS CASSETTE 5 DETACHABLE LIDS	191
INSTRUMENTS CASSETTE 5 HINGED LIDS WITH BUTTON LOCK	191
INSTRUMENTS CASSETTE 5 PICES CASSETTE	191
INSTRUMENTS CASSETTE 5 HINGED	191
INSTRUMENTS CASSETTE 7 PICES CASSETTE	191
INSTRUMENTS TRAY PERFORATED	183,181
INSTRUMENTS TRAY PERFORATED BASE	191
INSTRUMENTS TRAY SOLID BASE	191
INSTRUMENTS TRAYS	183
INSTRUMENTS TRAYS WITH COVER	184
INSTRUMENTS TRAYS WITH LID	183
INSTRUMENTS TRAYS WITHOUT COVER	184
INTRALIGAMENTAL ANESTHESIA SYRINGE	27
IRIS GUM SCISSORS	104
IRIS SUPER CUT SCISSORS	108
IRIS GUM SCISSORS	104,105,108
IVORY SIGVELAND RETAINERS	115
IVORY LIGHT WEIGHT RUBBER DAM CLAMPS FORCEPS	111
IVORY MATRIX RETAINERS	115
IVORY RETRACTORS	111
IVORY RUBBER DAM CLAMPS FORCEPS	111
IWANSON SPRING CALIPER FOR METAL AND PORCELAIN	126
IWANSON SPRING CALIPER FOR WAX	126

J	
JACQUETTE SCALER	83
JARABAK PLIERS	143
JECT ULTIMA DENTAL SYRINGES	27
JENNINGS RETRACTORS - MOUTH GAGS	100
JOHNSON CONTOURING PLIERS	133
JOHNSON PLIERS FOR CROWN BAND CONTOURING	138
JONES TOWEL CLAMPS	110
JOSEPH GUM SCISSORS	105

K	
KALT NEEDLE HOLDERS T.C	109
KELLS EXTRACTING FORCEPS (AMERICAN PATTERN)	15

DESCRIPTION PAGE#

KELLY GUM SCISSORS 104,105
 KELLY HAEMOSTATIC FORCEPS 110
 KELLY-RANKIN HAEMOSTATIC FORCEPS 110
 KEY RINGS 94
 KEYS FOR IMPLANT SCREW 177
 KILNER (RAGNELL) GUM SCISSORS 105
 KIRLAND SCALER 64
 KLEIN EXTRACTING FORCEPS 28
 KLEINERT-KUTZ BONE ROUNDNER 28
 KOPF ROOTS ELEVATOR 39
 KRAMER NEVINS SINUS LIFT 162
 KRAMER-NEVINS PERIODONTAL INSTRUMENTS 121
 KRARNER-NEVINS BONE CHISEL 119
 KUEHNE TWEEZERS 130

L
 LA GRANGE NEEDLE HOLDERS 109
 LA GRANGE GUM SCISSORS 104,105
 LADMORE FILLING INSTRUMENTS 88
 LADMORE IMPLANTOLOGY 149
 LAGRANGE SCISSORS 108
 LAGRANGE SUPER CUT SCISSORS 108
 LANGENBECK RETRACTORS 103
 LANGER SCALER 63
 LAP & L KEY JOINT PLIERS 139
 LARGE FLUSH-CUT DISTAL AND CUTTING PLIERS 133
 LAKUTOR ROOT ELEVATORS 30,31
 LAKUTOR ROOT ELEVATORS SET OF 8 PCS 38
 LE CRON CEMENT SPATULAS 95
 LECLUSE BAYONET ROOT ELEVATOR 41
 LESSMANN WAX KNIVES 96
 LICHTENBERG-RYDER TC NEEDLE HOLDERS 109
 LIGATURE FORMING PLIERS 134
 LIGATURE INSTRUMENT SILICON GRIP 129
 LIGHT WORE BIRD BEAK PLIERS WITH GROOVE 143
 LINDO LEVIAN ROOT ELEVATORS 35
 LINGUAL / PALATAL ARCH FORMING PLIERS 134
 LINGUAL ARCH FORMING PLIERS 143
 LINGUAL DENTAL PHOTOGRAPHIC MIRRORS 98
 LINGUAL-PALATAL SURFACES SCALER 61
 LINGUAL-LARGE DENTAL PHOTOGRAPHIC MIRRORS 98
 LIP & CHEEK RETRACTOR 100
 L-KEY JOINT PLIERS 139a,139
 LOCKLIN GUM SCISSORS 105
 LONDON COLLEGE TWEEZERS 62
 LONDON HOSPITAL 34
 LONG IMPLANT DRILLS 178
 LOOP FORMING IN FOUR LENGTH 138
 LORNAEMOSTATIC FORCEPS 110
 LUCAS IMPLANTOLOGY 168
 LUER BONE ROUNDNER 100
 LURS 58
 LUXATING ELEVATOR / PERIOTOME 36
 LUXATING ELEVATOR WITH PERIOTOME TIP 36
 LUXATOR ROOT ELEVATORS 29
 LUXATORELEVATOR 8 PCS 191
 LUXATORS SET OF 7 PCS 46
 LUXATORS SET OF 7 PCS 46
 LUXATORS SET OF 8 PCS 46
 LUXER ROOTS ELEVATOR 40
 LUXIVATORS CURVED ATRAUMATIC LUXATION OF THE TOOTH 48
 LUXIVATORS STRAIGHT ATRAUMATIC LUXATION OF THE TOOTH 48

M
 MAGNIFYING MOUTH MIRRORS 49
 MALLET IMPLANTOLOGY 174
 MALLETS - PLASTER SHEARS - SAWS & BLADES 124
 MANUAL ASPIRATING SYRINGE 27
 MANUAL CROWN REMOVERS 114
 MARGIN TRIMMERS 66
 MARGINAL RIDGE & EMBRASURE SHAPING INSTRUMENT 148
 MARKLEY FILLING INSTRUMENTS 93
 MARQUETTE CONDENSER 87
 MARQUETTE PLUGGERS 87
 MARYAM TWEEZERS 53
 MATHIEU NEEDLE HOLDERS 107
 MATRIX RETAINERS 115
 MAXI HOLLOWARE INSTRUMENTS 187
 MAYO GUM SCISSORS 106
 MAYO NEEDLE HOLDERS 185
 MAYO TRAY PERFORATED 106,107
 MAYO-HEGAR NEEDLE HOLDERS 106,107
 MCCALL SCALER 63
 MEAD BONE ROUNDNER 25
 MEAD NON AUTO CLAVABLE PLASTIC TIPS 119
 MEASURING LOOP 128
 MEASURING LOOP CASTROVIEJO 128
 MEASURING PROBE 145
 MEISSNER EXTRACTING FORCEPS 26
 MEMBRANE IMPLANTOLOGY 161
 MEMBRANE POSITIONING IMPLANTOLOGY 150
 MEMBRANE DETACH ELEVATOR 164
 MEMBRANE ELEVATOR 164
 MEMBRANE TWEEZERS 170
 MERRIAM TWEEZERS 52
 MERRIT B EXPLORERS 55
 MERSHON BAND PUSHER 129
 MESH CASSETTES 5 PIECES, 7 PIECES, 10 PIECES, 15PIECES & 20 PIECES 190
 MESH TRAY 190
 MESH TRAYS 05 PCS 190
 MESH TRAYS 07 PCS 190
 MESH TRAYS 10 PCS 190
 MESH TRAYS 190
 MESH TRAYS 20 PCS 190
 MESSIAL SCALER 61
 METZENBAUM GUM SCISSORS 104,106
 MICOR ADSON 1X2 TISSUE FORCEPS 189
 MICRO BOLEY GAUGE STRAIGHT 146
 MICRO BOLEY GAUGE TWISTED 146
 MICRO IRIS GUM SCISSORS 104
 MICRO SURGICAL SCALPEL HANDLE TITANIUM 123
 MICRO-FRIEDMAN BONE ROUNDNER 25
 MICRO-MINI PIN & LIGATURE CUTTER 142
 MIDDELBORFF RETRACTORS 103
 MILLER BONE FILES 119
 MILLER ROOT ELEVATORS 37

DESCRIPTION PAGE#

MILLER IMPLANTOLOGY 168
 MILLER ROOT PLANNING FILES 119
 MILLER TWEEZERS 53
 MINI DISTAL AMALGAM CARRIERS 117
 MINI GAUGE 127
 MINI LIGATURE CUTTERS 133
 MINI PIN & LIGATURE CUTTER 142
 MINI PIN & LIGATURE CUTTER TC 139
 MINI-LANGENBECK RETRACTORS 102
 MINI-SPATEL BURNISHERS 71
 MINNESOTA RETRACTORS 101
 MIRROR EXPLORERS 51
 MIRROR HANDLE STEM WITH RULE HANDLES FOR MOUTH MIRRORS 50
 MISCELLANEOUS PRODUCTS 94
 MIXING SPATULA WITH SHOVEL 165
 MOLT 9 PERIODONTAL INSTRUMENTS 121
 MOLT AUTO CLAVABLE PLASTIC TIPS 119
 MONARI COMPOSITE MODELLING INSTRUMENTS 85
 MORTENSON FILLING INSTRUMENTS 80,87
 MOUTH MIRROR EXPLORERS 51
 MOUTH MIRRORS 49
 MOUTH PROPS 94
 MOVEABLE HEIGHT GAUGE 125
 MSY CEMENT SPATULAS 95
 MUELEMANN SCALER 64,85
 MULTIFUNCTIONAL METER 145
 MULTI-PURPOSE PLIERS 137

N
 NAKAWANI DENTAL LABORATORY INSTRUMENT 97
 NANCE LOOP FORMING PLIERS 132,137
 NAPKIN HOLDER WITH METAL CHAIN 94
 NAPKIN HOLDER WITH PLASTIC CHAIN 94
 NARROW SHOVELAND RETAINERS 115
 NEEDLE HOLDERS 106a,109
 NEEDLE STERILIZATION TUB 186
 NEUMANN GUM SCISSORS 105
 NEVINS EXTRACTING FORCEPS (AMERICAN PATTERN) 14,16
 NORMAL HANDLE EXPLORERS 54
 NOYES GUM SCISSORS 105

O
 OBTUSE IMPLANTOLOGY 161
 OCCLUSAL ANATOMY INSTRUMENT 148
 OHL PERIOSTEEL ELEVATORS 107
 OLSEN-HEGAR NEEDLE HOLDER WITH SCISSORS 107
 OMEGA LOOP FORMING PLIERS 141
 ORBAN SCALER 64
 ORTHO BAND PUSHER SCALER 131
 ORTHO INSTRUMENT 133
 ORTHO LIGATURE DIRECTOR SINGLE ENDED 131
 ORTHO LIGHT BAND PUSHER SCALER 129
 ORTHO LIGHT DOUBLE ENDED LIGATURE 131
 ORTHO LIGHT DOUBLE ENDED LIGATURE DIRECTOR 131
 ORTHO LIGHT DOUBLE ENDED LIGATURE DIRECTOR SCALER 129,131
 ORTHO LIGHT DOUBLE ENDED LIGATURE SCALER 131
 ORTHO LIGHT LIGATURE DIRECTOR DOUBLE ENDED 131
 ORTHO LIGHT SCALER 130
 ORTHO LIGHT SCALER DOUBLE ENDED 130
 ORTHO LIGHT SCALER HEAVY 130
 ORTHO LIGHT SCALER SINGLE ENDED 131
 ORTHO RULER / CONE SOCKET 146
 ORTHODONTIC INSTRUMENTS 129a,131
 ORTHODONTICS PLIERS STANDS 144
 ORTHOLITE LIGATURE DIRECTOR SCALER 131
 OSTEO METER MEASURING FORCEPS FOR JAW 146
 OSTEOHOME CONVEXES / CONCAVE / CONQUES 171,172
 OSTEOHOME CONVEXES / CONCAVE / CONQUES SET OF 5 PIECES 172

P
 P.K. THOMS WAXING INSTRUMENTS KIT 89
 P.K. THOMS WAXING INSTRUMENTS SOLID HANDLE 89
 PALATAL-ADULT DENTAL PHOTOGRAPHIC MIRRORS 98
 PALATAL-ADULT LARGE DENTAL PHOTOGRAPHIC MIRRORS 98
 PALATAL-CHILD DENTAL PHOTOGRAPHIC MIRRORS 98
 PALMER RUBBER DAM CLAMPS FORCEPS 111
 PARMLY EXTRACTING FORCEPS (AMERICAN PATTERN) 16
 PARTSCH PERIOSTEEL ELEVATORS 120
 PDL ELEVATORS 47,48
 PDL ELEVATORS SET OF 7 PCS 47
 PDL ELEVATORS SET OF 7 PCS 47
 PDL ELEVATORS SET OF 8 PCS 48
 PEDIATRIC TOOTH EXTRACTING FORCEPS SET 08
 PEET SPLINTER FORCEPS 109
 PERFORATED WITH RIM LOCK SET OF 06 PCS 179
 PERFORATED WITH RIM LOCK SET OF 10 PCS 179
 PERFORATED WITH RIM LOCK SET OF 8 PCS 179
 PERIODONTAL CHISELS 118
 PERIODONTAL INSTRUMENTS 120a,122
 PERIODONTAL KNIVES 64
 PERIODONTAL PROBES 58
 PERIODONTAL PROGRESSREADERS 57
 PERIODONTAL SURGERY 162
 PERIOSTEEL ELEVATORS 120,154
 PERIOTOME ROOTS ELEVATOR 43
 PERRY TWEEZERS 52,53
 PHYSIC EXTRACTING FORCEPS (AMERICAN PATTERN) 18
 PIN & LIGATURE CUTTER 142
 PIN & LIGATURE CUTTERS TC 139
 PIN HOLDING PLIER TC 140
 PIN-TWEEZERS 170
 PLAIN MOUTH MIRRORS 49
 PLANATOR 89
 PLANATOR 89
 PLASTER KNIFE 66
 PLASTER SHEARS 124
 PLASTIC FILLING INSTRUMENTS 93
 PLIER STAND PLASTIC 144
 PLIER STAND STAINLESS STEEL 144
 PLIERS FOR ORTHODONTICS & PROSTHETICS 132a,143
 PLIERS STAND STAINLESS ROD (ALUMINUM ANODIZED) 144
 PLUGGERS 56
 PLUGGERS/CONDENSERS 87
 POSITIONING 3 IMPLANTOLOGY 161

DESCRIPTION PAGE#

POSITIVE POSITIONER	125
POSTERIOR BAND REMOVING PLIERS - LONG	141
POSTERIOR BAND REMOVING PLIERS - SHORT	141
POITTS "T-HANDLE" ELEVATOR-LEFT	41
POITTS "T-HANDLE" ELEVATOR-RIGHT	41
PRICHARD PERIODONTAL INSTRUMENTS	121
PROBE EXPLORERS	51
PRONG 3 CLASP ADJUSTABLE PLIER TC.	140
Q	
QUATRO DENTAL SYRINGES	27
R	
RASPATOR, PRICHARD	165
RASPATOR, RASPIATORY	120
RASPATOR, WILLIGER	120
RECTANGULAR ARCH BENDING PLIERS	143
RETRACTOR SELDIN	103
RETRACTORS - MOUTH GAGS	96,100
RETRACTORS	101,103
RHODIUM MOUTH MIRRORS	49
RIBBON RETRACTORS	101
RIDGE MAPPING DOUBLE CALIPER	140
RING 2 DENTAL SYRINGES	27
ROCHESTER-KOCHER HAEMOSTATIC FORCEPS	110
ROCHESTER-PEAR HAEMOSTATIC FORCEPS	110
ROOT CANAL PLUGGER	56
ROOT ELEVATOR	296,48
ROOT ELEVATORS SET OF 10 PCS	46
ROOT FRAGMENT FORCEPS	99,11
ROOT PICK ELEVATOR WITH GOLD FLEXIBLE POINTS	42
ROOT PLANNING FILES	119
ROOT PLANNING FILES & BONE FILES	119
ROOTS SPLINTER FORCEPS	10
ROBER-KÖNIG RETRACTORS - MOUTH GAGS	100
ROUND AND CONCAVE PLIER	139
ROUND ENDODONTIC BOXES	186
ROUND EXCAVATOR	86
ROUND TORQUE WRENCH UNIVERSAL	177
ROUTURER EXTRACTING FORCEPS (ENGLISH PATTERN)	03
ROUTURER EXTRACTING FORCEPS FOR LOWER MOLARS	03
RUBBER DAM CLAMPS	113
RUBBER DAM CLAMPS FORCEPS	111
RUBBER DAM CLAMPS KITS	111
RUBBER DAM FRAME	111
RUBBER DUM TEMPLATE	112
RULER	127
RULER WEDGE	127
RUSSIAN LONG TISSUE FORCEPS	170
RUSSIAN TISSUE FORCEPS	170
RYDER NEEDLE HOLDERS	106,107
S	
SAW BLADES	124
SCALER	596,67
SCALERS TRAYS	183
SCALPEL HANDLE STRAIGHT	123
SCALPEL HANDLES	123
SCHLEMMER ROOTS ELEVATOR	37
SCHMOLIN PERIODONTAL INSTRUMENTS	122
SCHURE BAND SEATER	130
SCHWARZ PLIERS	139
SEPARATING ELASTIC PLIER	111
SELDIN PERIODONTAL INSTRUMENTS	122
SELDIN ROOT ELEVATORS	29,32
SELF LOCKING GROOVED	189
SELF-LOCKING TWEEZER	53
SEMKEN TAYLOR TWEEZERS	52
BENN MUELLER RETRACTOR	102
SERRATED PLUGGERS	84
SET OF 5 PIECES	171
SHEPHERD'S HOOK EXPLORER	54
SHORT IMPLANT DRILLS	176
SICKLE SCALERS	63
SIMPLEX RETRACTOR	100
SINUS ELEVATOR & MEMBRANE LIFT TIPS	184
SINUS IMPLANTOLOGY	156,161
SINUS LEFT ELEVATOR & MEMBRANE LIFT TIPS 3 SET OF 7 PCS	164
SINUS LEFT ELEVATOR SET OF 10 PCS	158
SINUS LEFT ELEVATOR	151,157
SINUS LEFT ELEVATORS SET OF 7 PCS WITH CASSETTE	157
SINUS LIFT INSTRUMENT	150,152,161
SINUSLIFT IMPLANTOLOGY	150,161
SIOVELAND RETAINERS	115
SLIM WEINGART PLIERS	141
SLIPPER TWEEZERS	128
SMAHA ELASTOMERIC LIGATURE PLACING FORCEPS	140
SMALL/MEDIUM BALL BURNISHER	149
SOFT BRUSHING KIT SET OF 6 PCS	163
SOFT WIRE AND LIGATURE CUTTER	135
SOFT WIRE AND LIGATURE CUTTER, STANDARD	135
SPATULAS	73
SPATULAS ROUNDED AND SHARP	72
SPECIAL INOX	124
SPECIAL INOX WAX KNIVES	96
SPENCER GUM SCISSORS	105
SPIRIT LAMP	166
SPLINTER FORCEPS	167
SPOON AND PUSHER (TRINOV)	167
STANDARD LIGATURE CUTTER TC.	139
STAR TORQUE WRENCH UNIVERSAL	177
STERILIZING BOXES & INSTRUMENTS TRAYS	164
STERILIZING MESH TRAY	180
STERNBERG RETRACTORS	99
STIEGLITZ ROOT FRAGMENTS	10
STIEGLITZ SPLINTER FORCEPS	10
STOCKES RUBBER DAM CLAMPS FORCEPS	111
STOP PLIERS V-BEBO	137
STRAIGHT DIRECT BOND BRACKET REMOVER TC.	140
STRIP SAW	125
SUCTION CANNULA KIT WITH 3 NEEDLES	178
SUCTION NEEDLE	178
SUCTION PIPE	178
SUCTION TUBES	178
SURGICAL TWEEZERS	52

DESCRIPTION PAGE#

SURGICAL BALL HOOK CRIMPING PLIERS, ANGLED	137
SURGICAL BALL HOOK CRIMPING PLIERS, STRAIGHT	137
SURGICAL CHISELS	162
SUTURE PLIERS SUTURE FORCEPS	169
SWEDISH TYPE DENTAL SYRINGES	27
SYNDESMOTOMES ROOTS ELEVATOR	43
T	
TAMPER	169
TANNER FILLING INSTRUMENTS	89
TARTAR REMOVER INSTRUMENTS SOLID HANDLE	87
TAYLOR SCALER	63
THICK EXPLORERS	54
THREE JAW PLIERS	143
TISSUE GRAFT FORCEP SERRATED TEETH	169
TISSUE MEMBRANE FORCEPS	166,170
TISSUE PUNCH	173
TISSUE PUNCH FORCEPS TO REMOVE TISSUE AFTER USING PUNCH	170
TISSUE PUNCH SET OF FIVE PIECES	173
TISSUE PUNCH STRAIGHT & CURVED	173
TISSUE PUNCH WITH PIN SET OF FOUR PIECES	173
TITANIUM LOCKING PLIER	169
TITANIUM PERIOSTEAL ELEVATOR FOR IMPLAN	122
TOFFLEMIRE-JUNIOR SIOVELAND RETAINERS	115
TOFFLEMIRE-SENIOR SIOVELAND RETAINERS	115
TOMAS EXTRACTING FORCEPS (AMERICAN PATTERN)	17,22
TORONS NEEDLE HOLDERS	109
TORQUE WRENCH & RATCHET	177
TORQUING PLIERS SET	137
TOWNER-JAQUETTE SCALER	63
TREPHINE	175
TREPHINE DRILL SET OF EIGHT PIECES	175
TRINOV HANDLE	167
TRIO DENTAL SYRINGES	27
TRIPLE-ANGLED BACK ACTION EXCAVATOR	86
TWEED / ANGEL FORMING AND TORQUING PLIERS	134
TWEED / ANGEL RECTANGULAR ARCH FORMING AND TORQUING PLIERS	137
TWEED / ANGLE RECTANGULAR ARCH FORMING & TORQUING PLIERS	133
TWEED LOOP FORMING PLIERS	132,133,143
TWEEZERS	62,53
TWEEZERS EXPLORERS	51
TWEL-ON ELASTIC MODULE INSTRUMENT	130
TYPE C DENTAL SYRINGES	27
U	
UNIQUE RETRACTORS	102
UNIVERSAL CROWN REMOVER	114
UNIVERSAL CURETTES	63
UNIVERSAL CUT & HOLD DISTAL END CUTTER	142
UNIVERSAL DOLPHIN STYLE WIRE BENDING & CUTTING PLIERS	132
UNIVERSAL EXTRACTING FORCEPS (AMERICAN PATTERN)	22
UNIVERSAL MINI-ELEVATOR FOR FRAGMENTS	34
UNIVERSAL NEEDLE HOLDERS	106
UNIVERSITY OF MICHIGAN EXPLORERS	55
UNIVERSITY OF NORTH CAROLINA EXPLORER	55
UPPER ROOT ELEVATOR WITH HELICOIDAL TIP	31
US ARMY RETRACTORS	102
UTILITY PLIER WEINGART TC.	140
V	
V BEND STOP	139
V BEND STOP PLIER TC.	139
VERNER GALOGE	127
VISTA TUNNELING INSTRUMENTS SET	155
W	
W BARRY ROOTS ELEVATOR	41
WAHL BONE FILES	119
WAKAI HEAT CARRIERS	57
WALDSAHS WIRE BENDING AND CUTTING PLIERS	134
WANGEN HOLDER	99
WARD FILLING INSTRUMENTS	80
WATER SYRINGE	116
WAX KNIVES	96
WAY 6 ADJUSTABLE ANGLED SCALPEL HANDLE	123
WEIDER RETRACTOR	99
WEINGART PLIER	139
WEINGART PLIER MEDIUM	132,134
WEINGART PLIERS	141
WEINGART UTILITY PLIERS	136
WEINGART-MINI UTILITY PLIERS	136
WEITLANER RETRACTORS - MOUTH GAGS	100
WERDELSTAEDT SCALER	67
WESTCOTT BURNISHERS	68
WESTCOTT FILLING INSTRUMENTS	93
WESTON CEMENT SPATULAS	95
WHITE BURNISHERS	68
WIDE SIOVELAND RETAINERS	115
WILAND SCALER	65
WILKINS/TUFTS EXPLORER	54
WILLIAMS EXPLORERS	55
WILLIAMS FILLING INSTRUMENTS	81
WINTER EXTRACTING FORCEPS (AMERICAN PATTERN)	12
WINTER ROOTS ELEVATOR	41
WIRE BENDING & LOOP FORMING PLIERS	132
WIRE BENDING AND LOOP FORMING PLIERS ANGLED (BIRD BEAK)	136
WISDOM EXTRACTING FORCEPS	03
WISDOM ROOT ELEVATOR	36
WITZEL FORCEPS WITH ANATOMICAL HANDLE SET OF 3 PCS	09
WITZEL FORCEPS WITH GOLD SET OF 3 PCS	09
WITZEL FORCEPS WITH HOLE AND SCREW PATTERN SET OF 3 PCS	09
WITZEL ROOT FRAGMENT FORCEPS	09
WOODEN HANDLE WAX KNIVES	96
X	
X RAY FILM HANGERS	94
Y	
YOUNG TONGUE FORCEPS	110
YOUNG WIRE BENDING & LOOP FORMING PLIERS	132
YOUNGER GOOD SCALER	63
Z	
ZAHLE CEMENT SPATULAS	95

NEW EDITION

DENTAL

INSTRUMENTS

Extraction Sets
Extracting Forceps
Root Elevators
Bone Rongeurs
Orthodontic Pliers
Scalers
Impression Trays



Branch Office:

NOVA CHORUS TRADING

Commercial Registration No: 225469

 : www.novachorus.com.qa

 : info@novachorus.com.qa

 : +974 7445 7038

 : Tornado Tower, West Bay,
Doha, State Of Qatar

